

Second Generation

Service
Service
Service



Service Manual

TABLE OF CONTENTS

	Page
Location of PCB Boards & version variation & repair scenario matrix.....	1-2
Production Specifications	1-3
Safety Instruction, Warning & Notes.....	1-6
DFU Instruction.....	2-1
Mechanical and Dismantling Instructions	3-1
Software Upgrades.....	4-1
Trouble Shooting Chart	5-1
Wiring Diagrams	6-1
Electrical Diagrams and Print-layouts	7-1
Set Mechanical Exploded view	8-1
Revision List	9-1

This service manual is for HTS3592 Second Generation model, which is different from the previous generation HTS3592/93 model.

For Second Generation model the serial number begin with KX2AXXXXXXXXXX. Refer to the rating label illustration at right.

PHILIPS 家庭影院系统播放器 型号: HTS3592/93
 220-240V~ 50Hz 110W 生产日期: XXXX 年XX 月
 中国制造

型号: HTS3592/93

序列号: KX2A120000001

**CLASS 1
LASER PRODUCT**

© Copyright 2010 Philips Consumer Electronics B.V. Eindhoven, The Netherlands
 All rights reserved. No part of this publication may be reproduced, stored in a retrieval system or transmitted, in any form or by any means, electronic, mechanical, photocopying, or otherwise without the prior permission of Philips.

Published by Helen-RY 1207 Service Audio Printed in The Netherlands Subject to modification

CB 313978536101

Version 1.1



PHILIPS

PCB BOARD LOCATION:

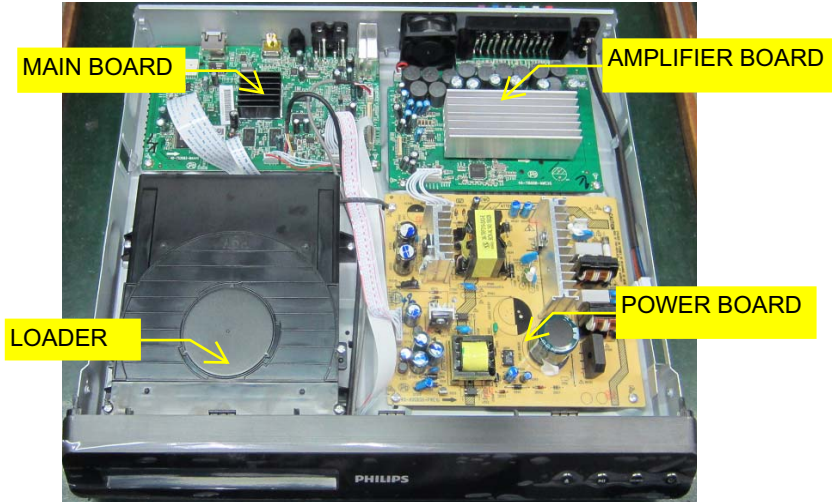

Version Variation

Type/Versions	HTS3592M2
	/93
Features	
Power supply rating:220-240V ,50Hz	X
Power consumption:110W	X

Repair Scenario Matrix

Type/Versions	HTS3592M2
	/93
Board in used	
Main Board	C
Front Control Board	C
Amplifier Board	C
Power Board	C

*Bd:Board Level Replacement

*C:Component Level Repair

HTS3592M2/93

Product Specifications:

Note

- Specifications and design are subject to change without notice.

Region codes

The type plate on the back or bottom of the home theater shows which regions it supports.

Country	DVD	BD
China	 	

Media formats

- AVCHD, BD, BD-R/ BD-RE, BD-Video, DVD-Video, DVD+R/+RW, DVD-R/-RW, DVD+R/-R DL, CD-R/CD-RW, Audio CD, Video CD/SVCD, Picture files, MP3 media, WMA media, DivX Plus HD media, USB storage device
- RMVB (Available only in Asia Pacific and China)

File formats

- Audio: .aac, .mka, .mp3, .wma, .wav, .mp4, .m4a
- Video:
 - .avi, .divx, .mp4, .mkv, .asf, .wmv, .mpg, .mpeg
 - .rmvb, .rm (Available only in Asia Pacific and China)
- Picture: .jpg, .jpeg, .gif, .png

Amplifier

- Total output power: 600W RMS (30%THD)
- Frequency response: 20 Hz-20 kHz / ± 3 dB
- Signal-to-noise ratio: > 65 dB (CCIR) / (A-weighted)
- Input sensitivity:
 - AUX: 2 V
 - Music iLink: 1 V

Video

- Signal system: PAL / NTSC
- HDMI output: 480i/576i, 480p/576p, 720p, 1080i, 1080p, 1080p24

Audio

- S/PDIF Digital audio input:
 - Coaxial: IEC 60958-3
 - Optical: TOSLINK
- Sampling frequency:
 - MP3: 32 kHz, 44.1 kHz, 48 kHz
 - WMA: 44.1 kHz, 48 kHz
- Constant bit rate:
 - MP3: 32 kbps - 320 kbps
 - WMA: 48 kbps - 192 kbps

Radio

- Tuning range:
 - Europe/Russia/China: FM 87.5-108 MHz (50 kHz)
 - Asia Pacific/Latin America: FM 87.5-108 MHz (50/100 kHz)
- Signal-to-noise ratio: FM > 45 dB
- Frequency response: FM 180 Hz-12.5 kHz / ± 3 dB

USB

- Compatibility: Hi-Speed USB (2.0)
- Class support: USB Mass Storage Class (MSC)
- File system: FAT16, FAT32, NTFS
- Maximum memory support: < 160 GB

Main unit

- Power supply: 220-240 V~, 50 Hz
- Power consumption: 110 W
- Standby power consumption: 0.9 W - 0.5 W
- Dimensions (WxHxD): 360 x 58 x 325 mm
- Weight: 2.62 kg

Subwoofer

- Output power: 100 W RMS (30%THD)
- Impedance: 4 ohm
- Speaker drivers: 133 mm (5.25") woofer
- Dimensions (WxHxD): 160 x 267.5 x 265 mm
- Weight: 2.55 kg

Speakers

Center speaker:

- Output power: 100 W RMS (30% THD)
- Speaker impedance: 4 ohm
- Speaker drivers: 1 x 63.5 mm (2.5") woofer
- Dimensions (WxHxD): 160 x 85 x 95 mm
- Weight: 0.37 kg

Front/Rear speaker:

- Output power: 4 x 100 W RMS (30% THD)
- Speaker impedance: 4 ohm
- Speaker drivers: 1 x 76.2 mm (3") twin driver
- Dimensions (WxHxD):
 - Speakers: 85 x 160 x 95mm
 - Tall speakers: 240 x 1007 x 240 mm
- Weight:
 - Speakers: 0.35 kg/each
 - Tall speakers: 1.57 kg/each

Remote control batteries

- 2 x AAA-R03-1.5V

Laser

- Laser Type (Diode): InGaN/AlGaIn (BD), AlGaInP (DVD/CD)
- Wave length: 405 +7 nm/-7 nm (BD), 655 +10 nm/-10 nm (DVD), 790 +10 nm/-20 nm (CD)
- Output power (Max. ratings): 20 mW (BD), 6 mW (DVD), 7 mW (CD)

Safety instruction, Warning & Notes

Safety instruction

1. General safety

Safety regulations require that during a repair:

- . Connect the unit to the mains via an isolation transformer.
- . Replace safety components indicated by the symbol , only by components identical to the original ones. Any other component substitution (other than original type) may increase risk of fire or electrical shock hazard.

Safety regulations require that after a repair, you must return the unit in its original condition. Pay, in particular, attention to the following points:

- . Route the wires/cables correctly, and fix them with the mounted cable clamps.
- . Check the insulation of the mains lead for external damage.
- . Check the electrical DC resistance between the mains plug and the secondary side:
 - 1) Unplug the mains cord, and connect a wire between the two pins of the mains plug.
 - 2) Set the mains switch the "on" position (keep the mains cord unplug).
 - 3) Measure the resistance value between the mains plug and the front panel, controls, and chassis bottom.
 - 4) Repair or correct unit when the resistance measurement is less than 1M Ω .
 - 5) Verify this, before you return the unit to the customer/user (ref. UL-standard no. 1492).
 - 6) Switch the unit "off", and remove the wire between the two pins of the mains plug.

2.Laser safety

This unit employs a laser. Only qualified service personnel may remove the cover, or attempt to service this device (due to possible eye injury).

Laser device unit

Type	: Semiconductor laser GaAlAs
Wavelength	: 650nm (DVD)
	: 780nm (VCD/CD)
Output power	: 7mW (DVD)
	: 10mW (DVD /CD)

Beam divergence: 60 degree

Note: Use of controls or adjustments or performance of procedure other than those specified herein, may result in hazardous radiation exposure. Avoid direct exposure to beam.

Warning

1. General

. All ICs and many other semiconductors are susceptible to electrostatic discharges (ESD). Careless handling during repair can reduce life drastically. Make sure that, during repair, you are at the same potential as the mass of the set by a wristband with resistance. Keep components and tools at this same potential. Available ESD protection equipment:

- 1) Complete kit ESD3 (small tablemat, wristband, connection box, extension cable and earth cable) 4822 310 10671.
- 2) Wristband tester 4822 344 13999.

. Be careful during measurements in the live voltage section. The primary side of the power supply, including the heat sink, carries live mains voltage when you connect the player to the mains (even when the player is "off!"). It is possible to touch copper tracks and/or components in this unshielded primary area, when you service the player. Service personnel must take precautions to prevent touching this area or components in this area. A "lighting stroke" and a stripe-marked printing on the printed wiring board, indicate the primary side of the power supply.

. Never replace modules, or components, while the unit is "on".

2. Laser

- . The use of optical instruments with this product, will increase eye hazard.
- . Only qualified service personnel may remove the cover or attempt to service this device, due to possible eye injury.
- . Repair handling should take place as much as possible with a disc loaded inside the player.
- . Text below is placed inside the unit, on the laser cover shield:

**CAUTION: VISIBLE AND INVISIBLE LASER
RADIATION WHEN OPEN, AVOID EXPOSURE
TO BEAM.**

Notes: Manufactured under licence from Dolby Laboratories. The double-D symbol is trademarks of Dolby Laboratories, Inc. All rights reserved.

Service Hints

CAUTION

CHARGED CAPACITORS ON THE SERVO BOARD MAY DAMAGE THE DRIVE ELECTRONICS WHEN CONNECTING A NEW DRIVE. THAT'S WHY, BESIDES THE SAFETY MEASURES LIKE

- **SWITCH OFF POWER SUPPLY**
- **ESD PROTECTION**

ADDITIONAL ACTIONS MUST BE TAKEN BY THE REPAIR TECHNICIAN.

The following steps have to be done when replacing the defective loader :

1. Dismantling of the loader to access the ESD protection point if necessary.
2. **Solder the ESD protection point***.
3. Disconnect flexfoil cable from the defective loader.
4. Put a paper clip on the flexfoil to short-circuit the contacts (fig.1)
5. Replace the defective loader with a new loader.
6. Remove paperclip from the flexfoil and connect it to the new loader.
7. Remove solder joint on the ESD protection point.

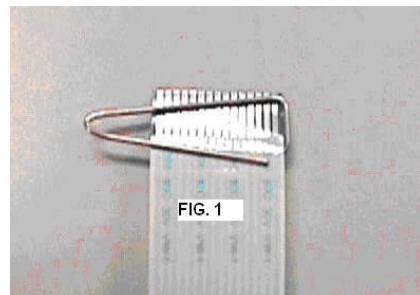

ATTENTION: The laser diode of this loader is protected against ESD by a solder joint which shortcircuits the laserdiode to ground. For proper functionality of the loader this solder joint must be remove **after** connection loader to the set.

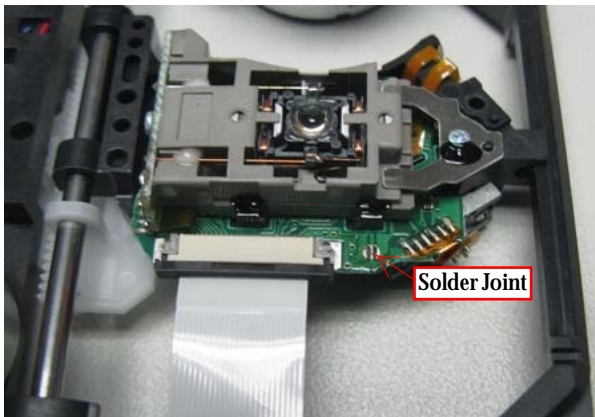

(ESD protection point is accessible from top of loader)

****Only applicable for defective loader needed to be sent back to supplier for failure analysis and to support backcharging evidence.***

This is also applicable for all partnership workshops.

Notes

Lead-Free requirement for service

IDENTIFICATION:

Regardless of special logo (not always indicated) 

One must treat all sets from 1.1.2005 onwards, according next rules.

Important note: In fact also products a little older can also be treated in this way as long as you avoid mixing solder-alloys (leaded/ lead-free). So best to always use SAC305 and the higher temperatures belong to this.

Due to lead-free technology some rules have to be respected by the workshop during a repair:

- Use only lead-free solder alloy Philips SAC305 with order code 0622 149 00106. If lead-free solder-paste is required, please contact the manufacturer of your solder-equipment. In general use of solder-paste within workshops should be avoided because paste is not easy to store and to handle.
 - Use only adequate solder tools applicable for lead-free solder alloy. The solder tool must be able
 - To reach at least a solder-temperature of 400°C,
 - To stabilize the adjusted temperature at the solder-tip
 - To exchange solder-tips for different applications.
 - Adjust your solder tool so that a temperature around 360°C – 380°C is reached and stabilized at the solder joint. Heating-time of the solder-joint should not exceed ~ 4 sec. Avoid temperatures above 400°C otherwise wear-out of tips will rise drastically and flux-fluid will be destroyed. To avoid wear-out of tips switch off un-used equipment, or reduce heat.
 - Mix of lead-free solder alloy / parts with leaded solder alloy / parts is possible but PHILIPS recommends strongly to avoid mixed solder alloy types (leaded and lead-free). If one cannot avoid, clean carefully the solder-joint from old solder alloy and re-solder with new solder alloy (SAC305).
- Use only original spare-parts listed in the Service-Manuals. Not listed standard-material (commodities) has to be purchased at external companies.
 - Special information for BGA-ICs:
 - always use the 12nc-recognizable soldering temperature profile of the specific BGA (for de-soldering always use highest lead-free temperature profile, in case of doubt)
 - lead free BGA-ICs will be delivered in so-called 'dry-packaging' (sealed pack including a silica gel pack) to protect the IC against moisture. After opening, dependent of MSL-level seen on indicator-label in the bag, the BGA-IC possibly still has to be baked dry. This will be communicated via AYS-website.
 - Do not re-use BGAs at all.
 - For sets produced before 1.1.2005, containing leaded soldering-tin and components, all needed spare-parts will be available till the end of the service-period. For repair of such sets nothing changes.
 - On our website:
 - www.atyourservice.ce.Philips.com**

You find more information to:

BGA-de-/soldering (+ baking instructions)
Heating-profiles of BGAs and other ICs used in Philips-sets

You will find this and more technical information within the "magazine", chapter "workshop news".
For additional questions please contact your local repair-helpdesk.



Brief Guide

EN Before using your product, read all accompanying safety information

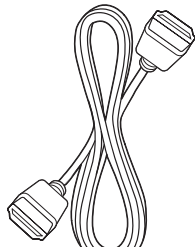
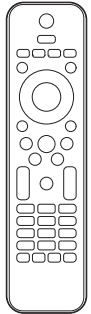

HDMI

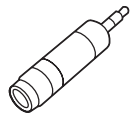
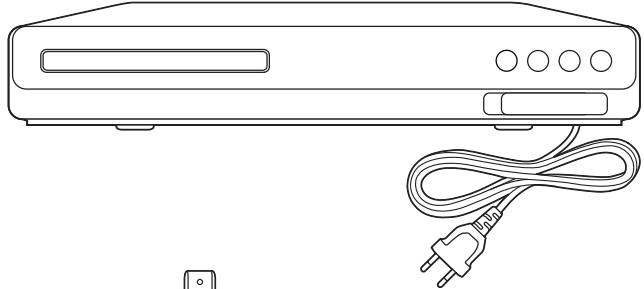

MIC-IN Converter

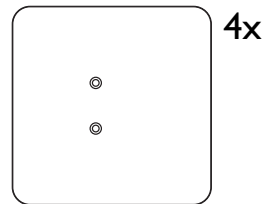
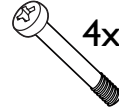
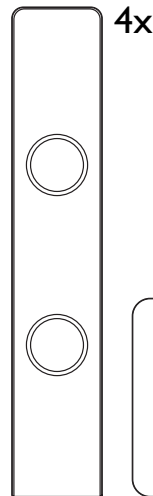
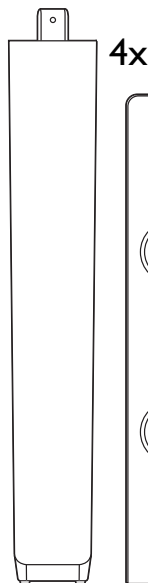
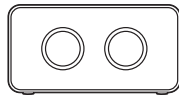
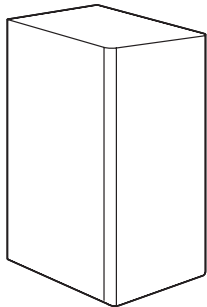
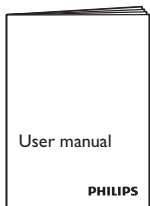

1

EN Stand mount the speakers

1

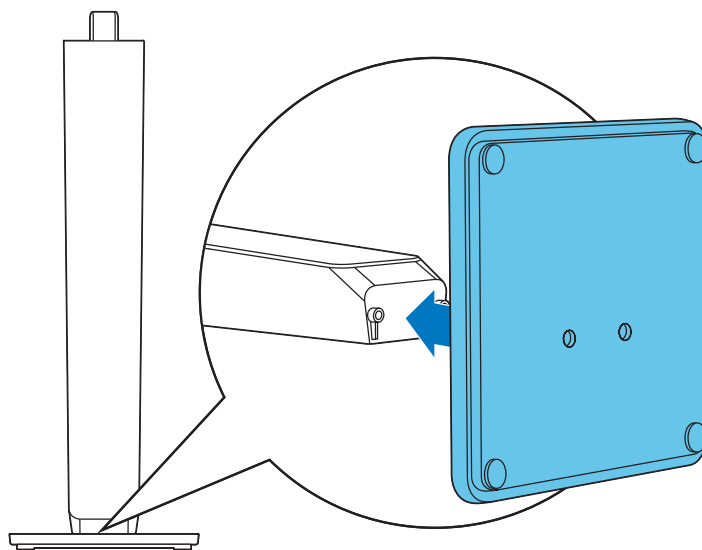

2

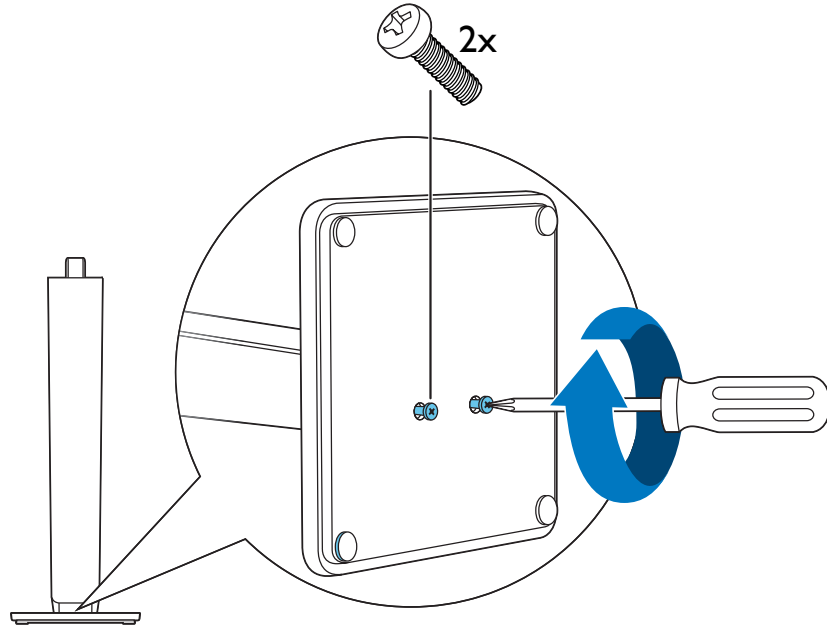

3

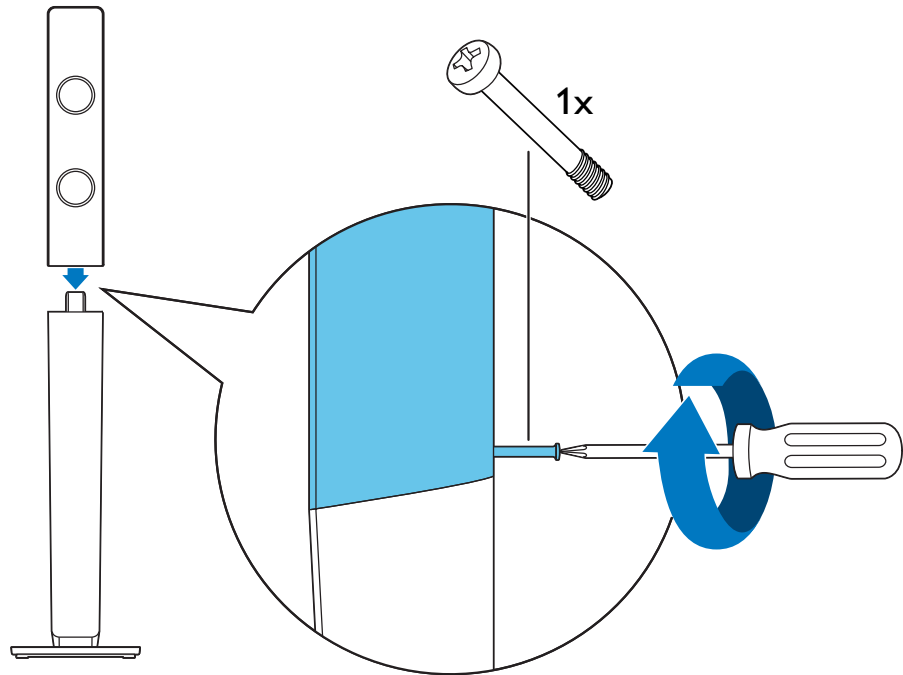

2

EN Connect the home theater

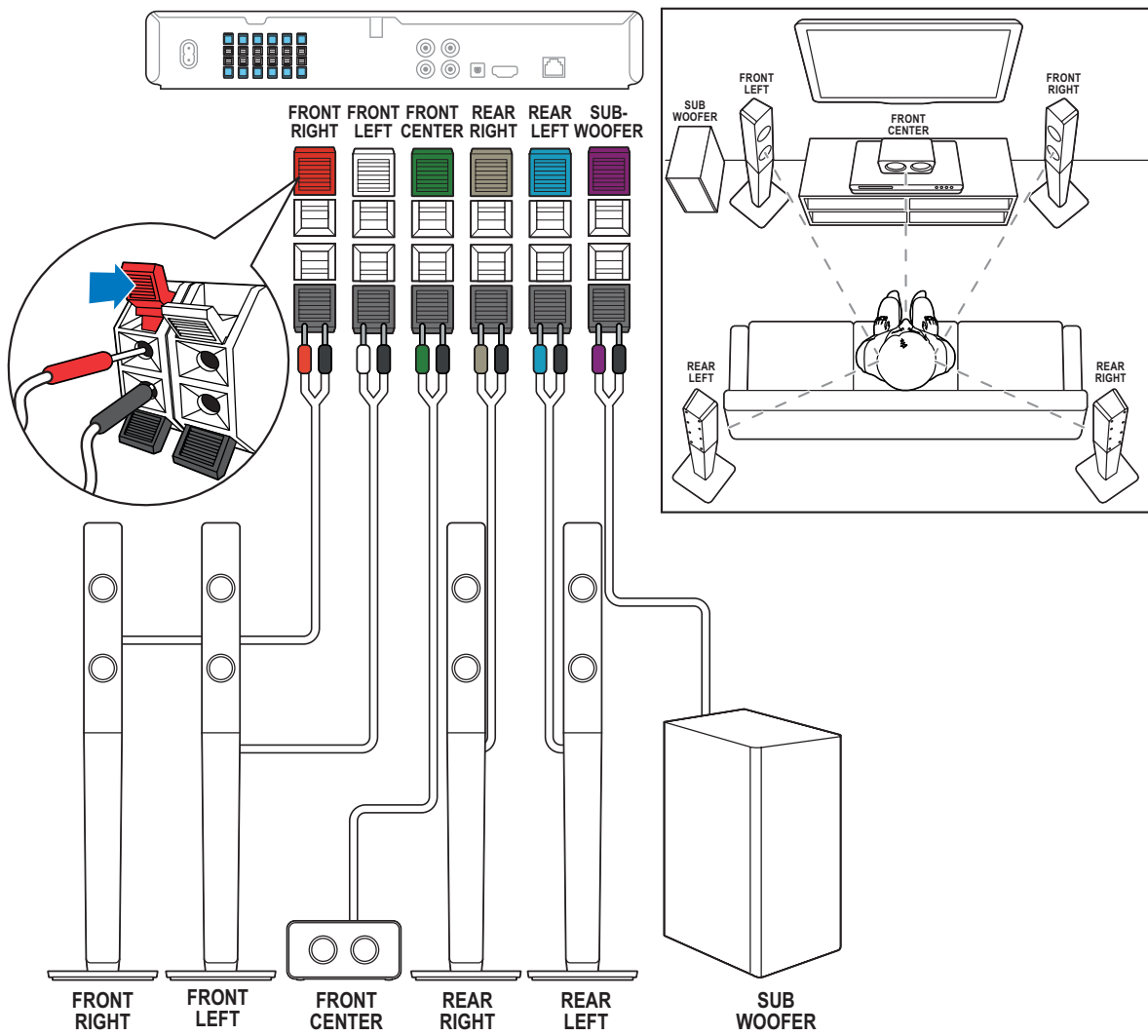

3

EN Connect to TV in one of these ways

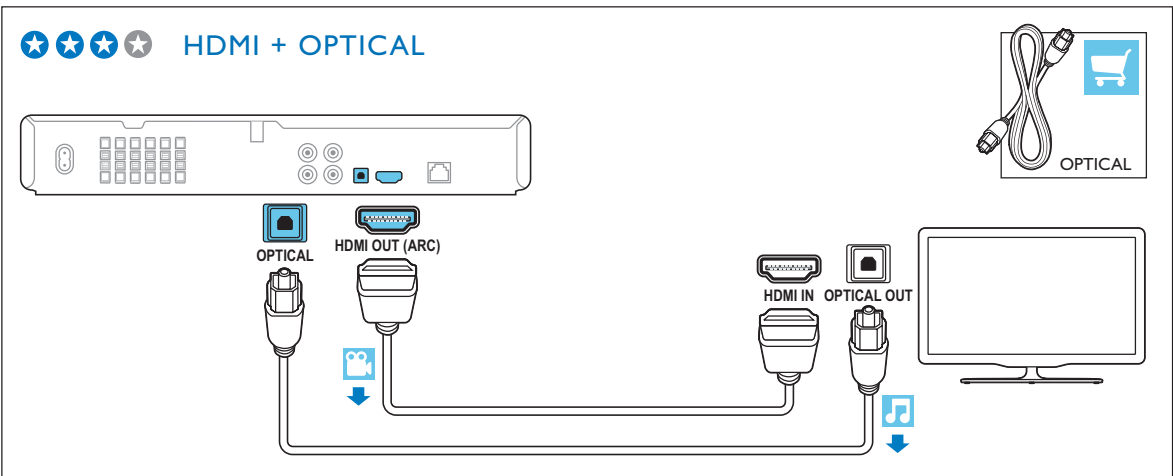
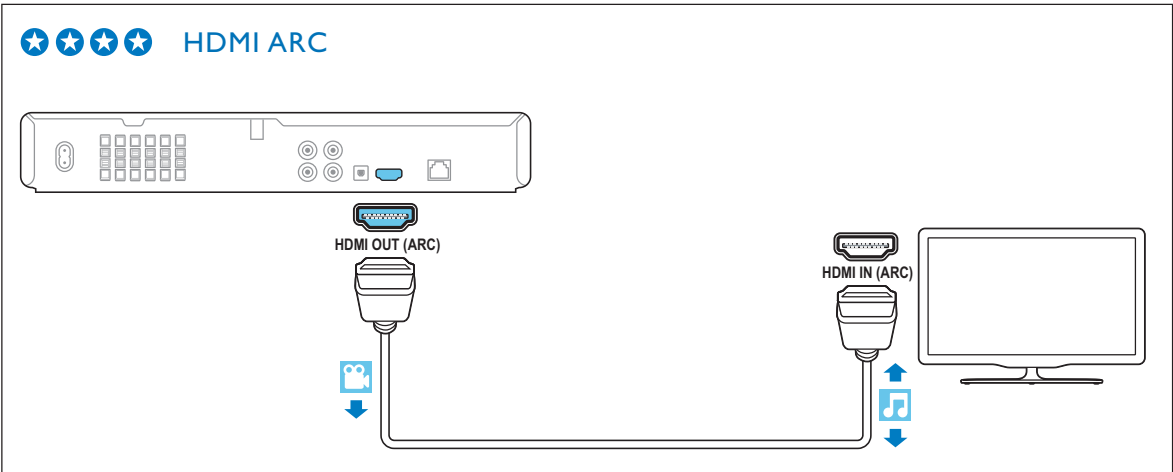

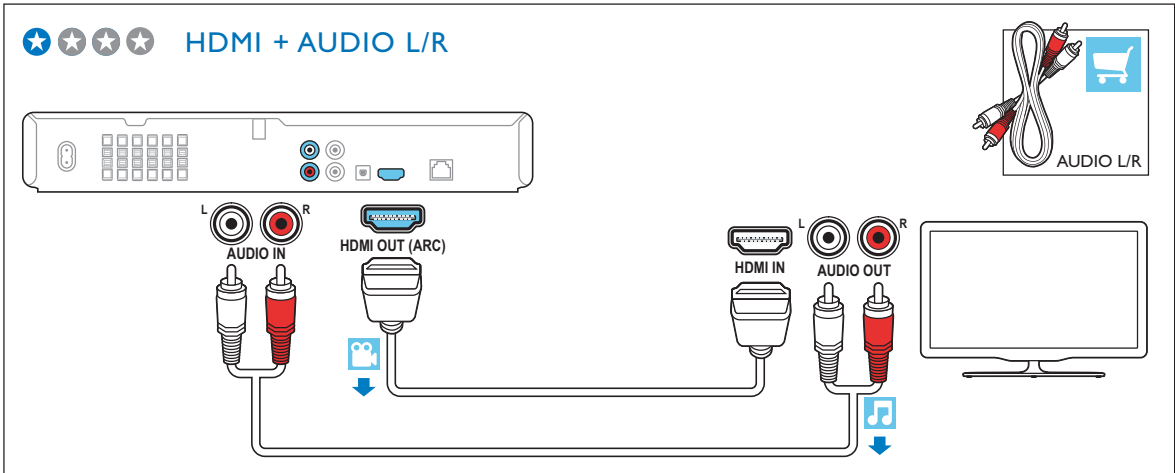
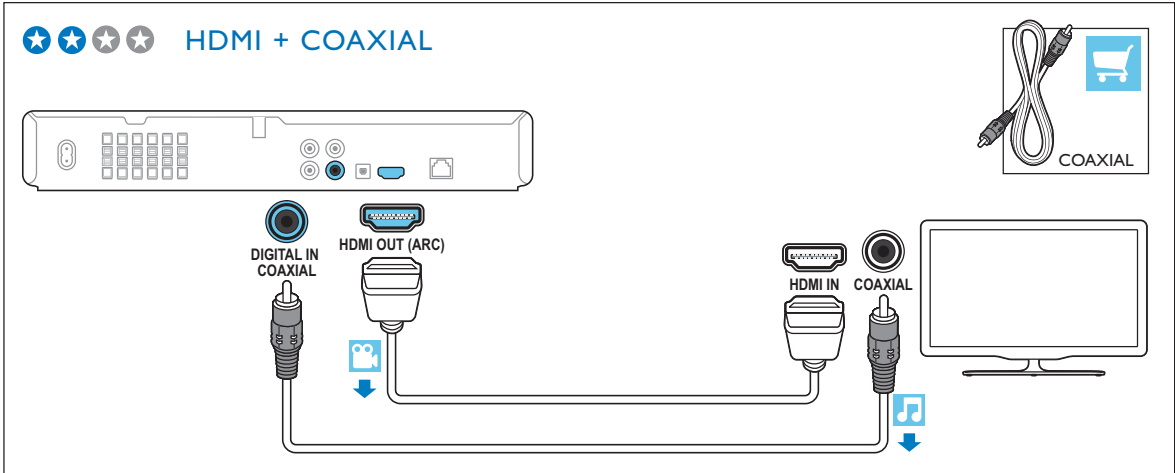

4

EN Switch on the home theater

1

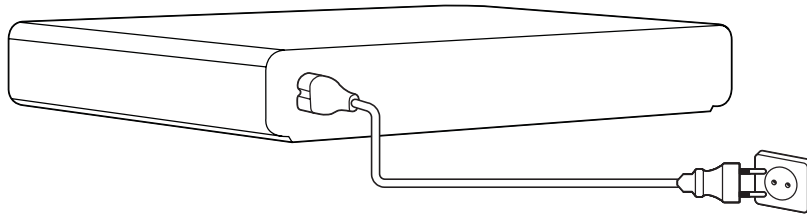

2

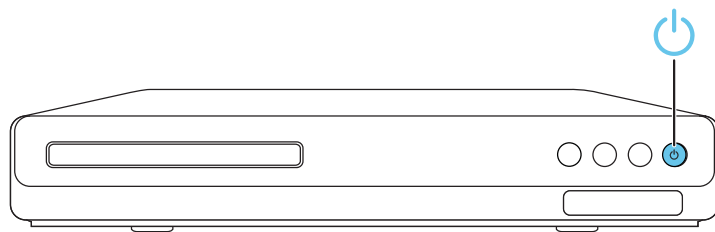

3

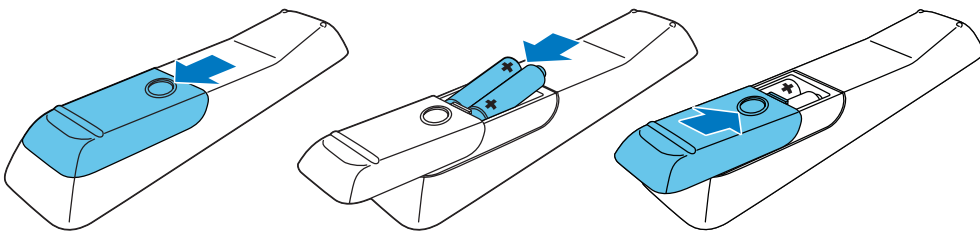

5

EN Complete the first time setup

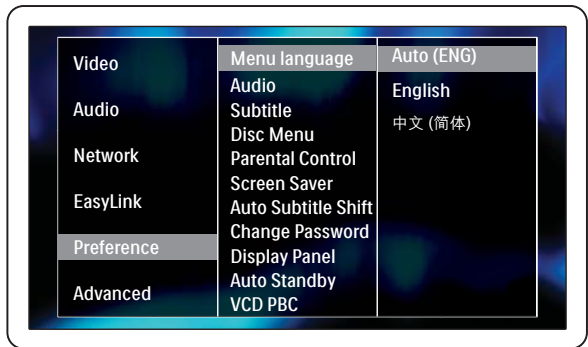
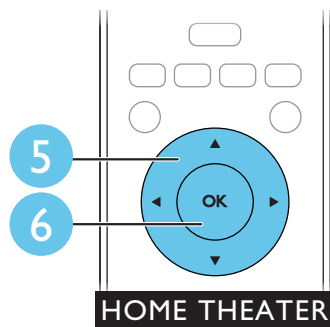
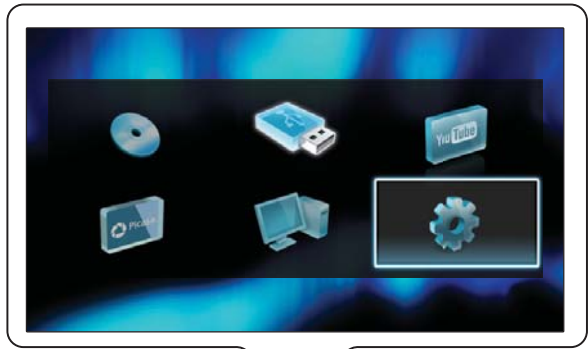
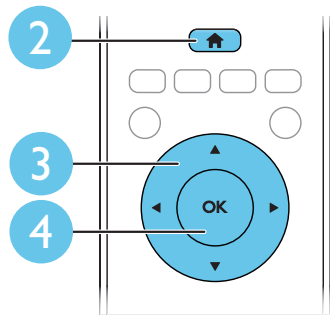
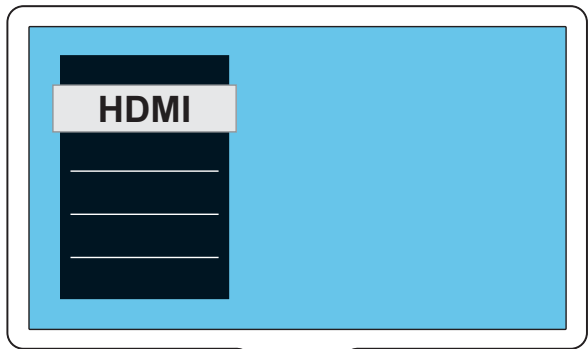
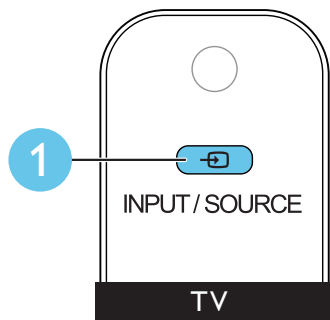

6

EN Use your home theater

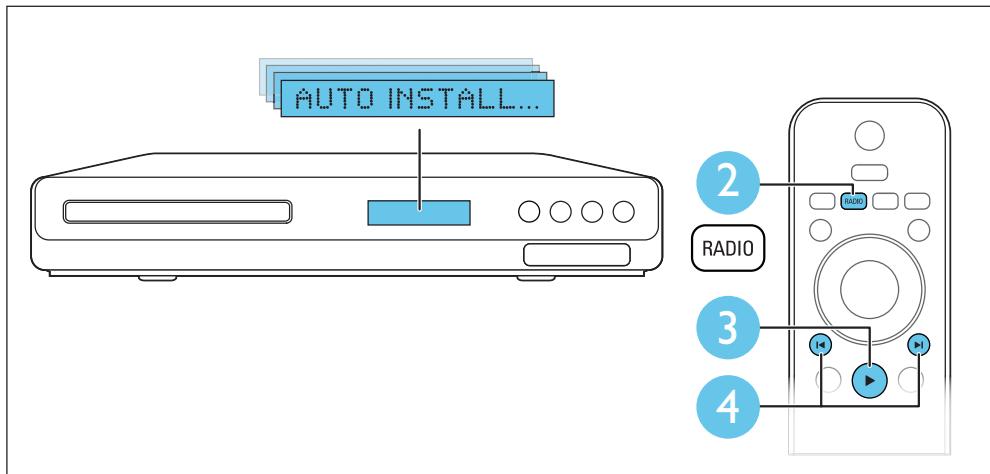
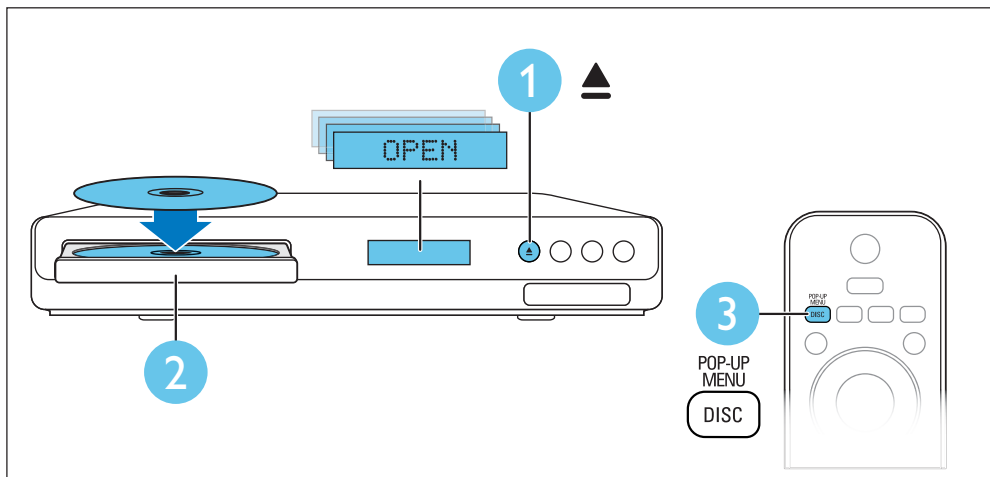
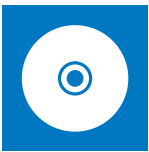

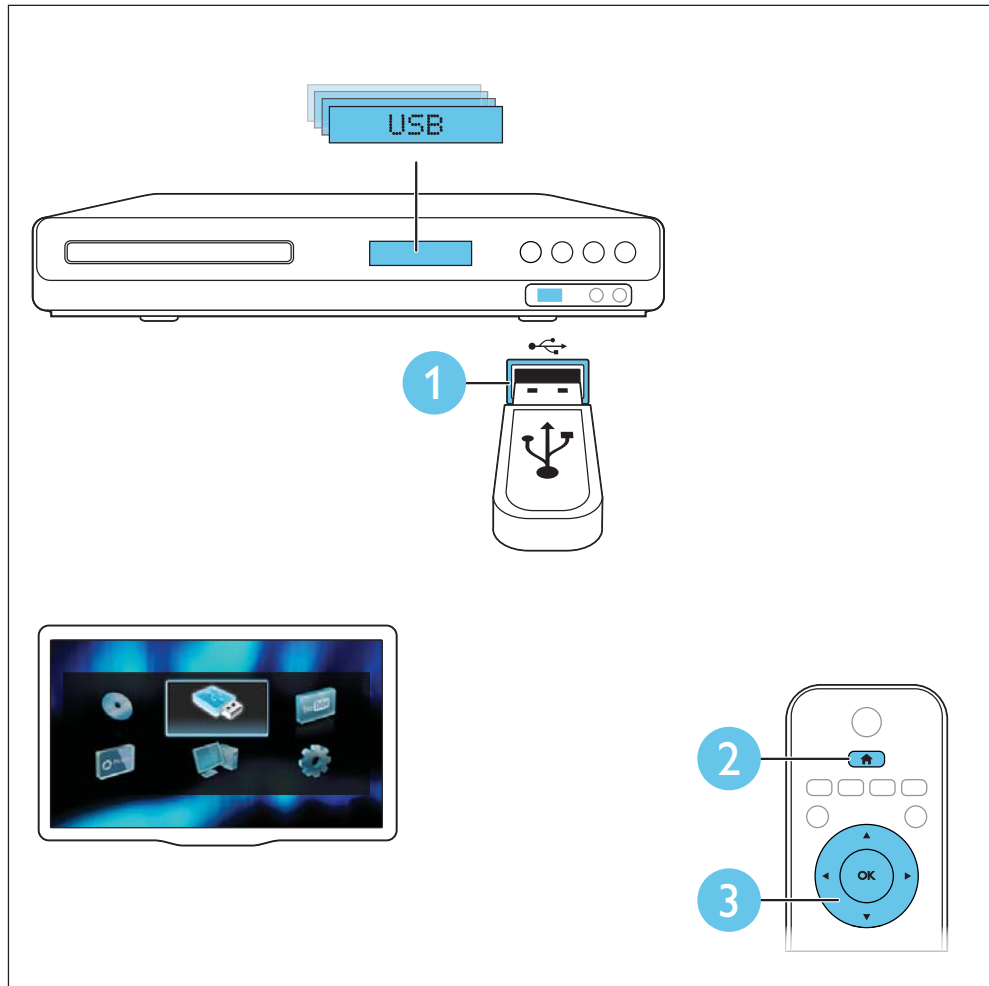
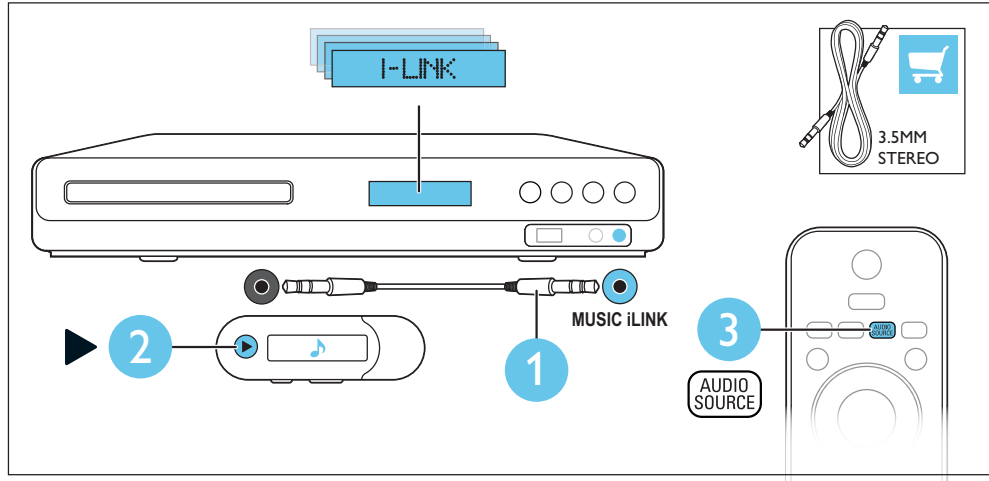

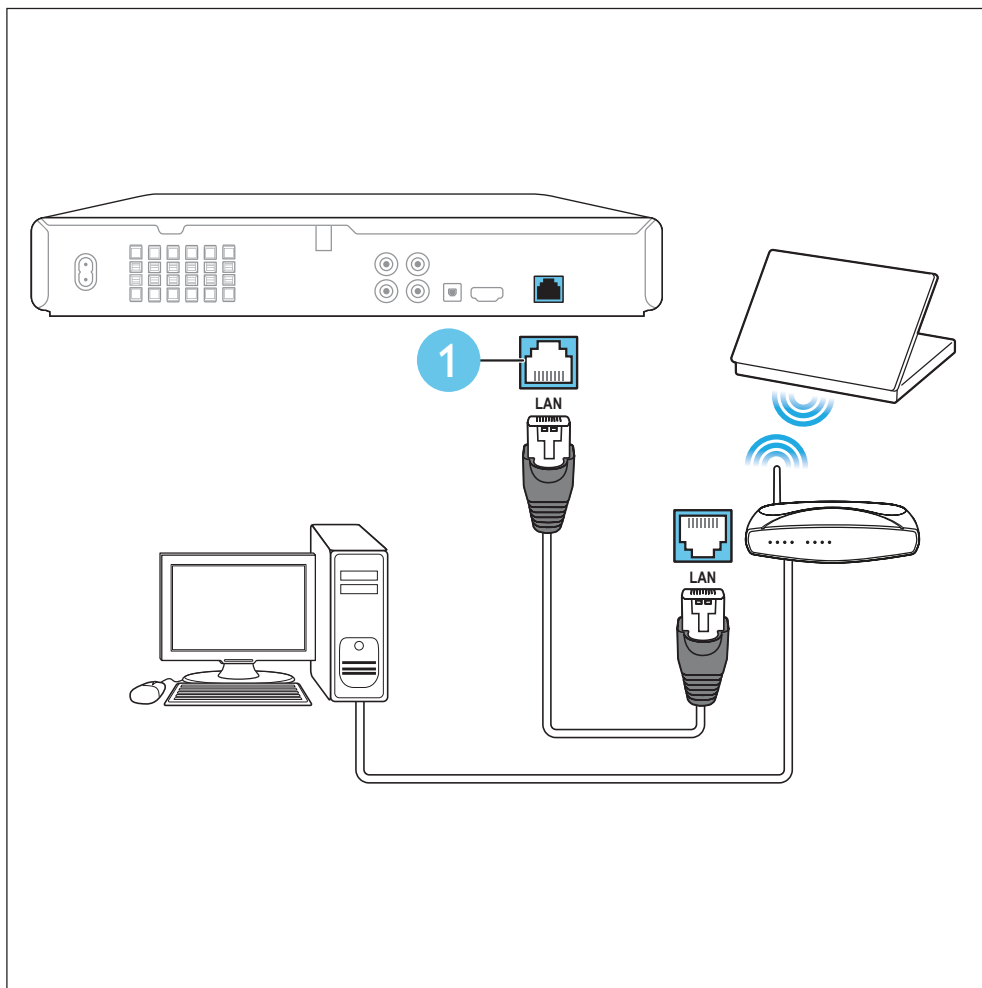

Your home theater

Congratulations on your purchase, and welcome to Philips! To fully benefit from the support that Philips offers, register your product at www.philips.com/welcome.

Main unit

This section includes an overview of the main unit.

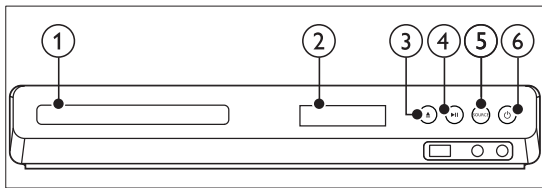

- ① **Disc compartment**
- ② **Display panel**
- ③ **▲ (Open/Close)**
Open or close the disc compartment, or eject the disc.
- ④ **▶|| (Play/Pause)**
Start, pause or resume play.
- ⑤ **SOURCE**
Select an audio or video source for the home theater.
- ⑥ **⏻ (Standby-On)**
Switch the home theater on or to standby.

Remote control

This section includes an overview of the remote control.

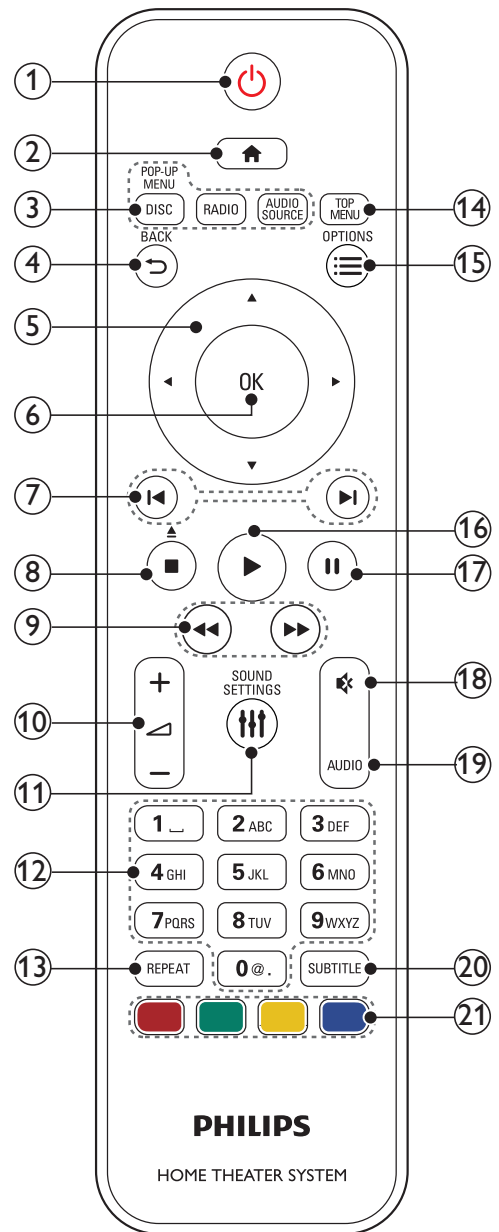

- ① **⏻ (Standby-On)**
 - Switch the home theater on or to standby.
 - When EasyLink is enabled, press and hold for at least three seconds to switch all connected HDMI CEC compliant devices to standby.
- ② **🏠 (Home)**
Access the home menu.
- ③ **Source buttons**
 - **DISC/POP-UP MENU** : Switch to disc source. Access or exit the disc menu when you play a disc.
 - **RADIO** : Switch to FM radio.
 - **AUDIO SOURCE** : Select an audio input source.
- ④ **⬅️ BACK**
 - Return to a previous menu screen.
 - In radio mode, press and hold to erase the current preset radio stations.
- ⑤ **Navigation buttons**
 - Navigate menus.
 - In radio mode, press left or right to start auto search.
 - In radio mode, press up or down to tune the radio frequency.
- ⑥ **OK**
Confirm an entry or selection.
- ⑦ **⏮️ / ⏭️ (Previous/Next)**
 - Skip to the previous or next track, chapter or file.
 - In radio mode, select a preset radio station.
- ⑧ **■ (Stop) / ▲ (Eject/Open/Close)**
 - Stop play.
 - Press and hold for three seconds to open or close the disc compartment, or eject the disc.
- ⑨ **⏪ / ⏩ (Fast Backward / Fast Forward)**
Search backwards or forward. Press repeatedly to change the search speed.
- ⑩ **🔊 +/- (Volume)**
Increase or decrease volume.
- ⑪ **🔊 SOUND SETTINGS**
Access or exit sound options.
- ⑫ **Alphanumeric buttons**
Enter values or letters (using SMS style entry).
- ⑬ **REPEAT**
Select or turn off repeat mode.
- ⑭ **TOP MENU**
Access the main menu of a disc.
- ⑮ **☰ OPTIONS**
 - Access more play options while playing a disc or a USB storage device.
 - In radio mode, set a radio station.
- ⑯ **▶️ (Play)**
Start or resume play.
- ⑰ **⏸️ (Pause)**
Pause play.
- ⑱ **🔇 (Mute)**
Mute or restore volume.
- ⑲ **AUDIO**
Select an audio language or channel.
- ⑳ **SUBTITLE**
Select subtitle language for video.
- ㉑ **Color buttons**
Select tasks or options for Blu-ray discs.

Mechanical and Dismantling Instructions

Dismantling Instruction

Detailed information please refer to the model set.

The following guidelines show how to dismantle the player.

Step1: Remove 6 screws around the Top Cover, and then remove the Top Cover (Figure 1).

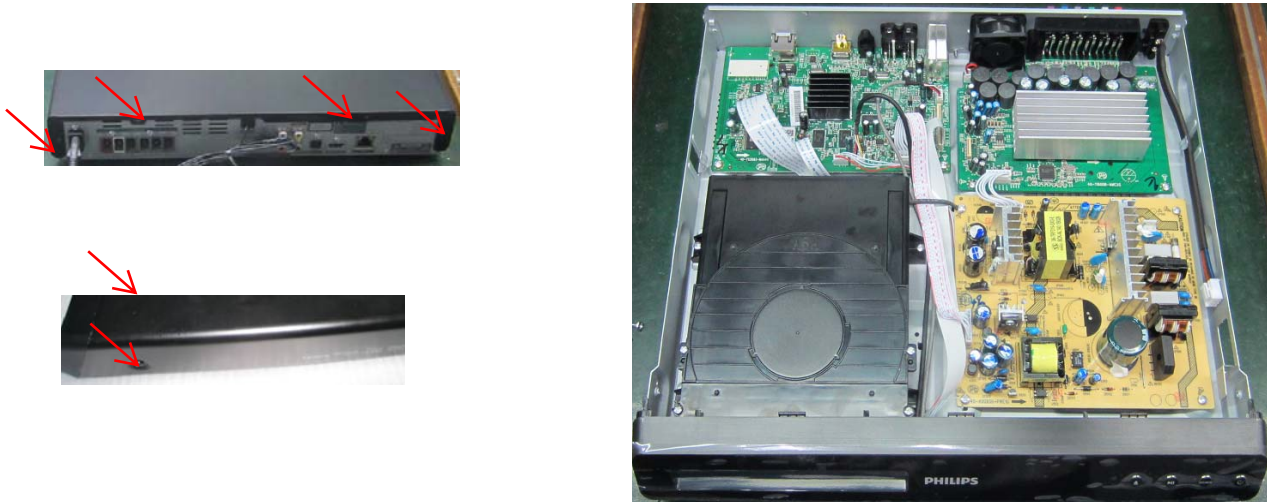

Figure 1

Step2: If it is necessary to dismantle Loader or Front Panel, the Front door should be removed first. (Figure 2)
Turn on the power button, then press open button to dismantle front door. Please kindly note that power off as soon as front door is out of machine.

Note: Make sure to operate gently otherwise the guider would be damaged.



Please kindly note that dismantle the front door assembly carefully to avoid damage tray and the front door.

Figure 2

Mechanical and Dismantling Instructions

Dismantling Instruction

Detailed information please refer to the model set.

Step3 :Dismantle Front Panel, disconnect the connectors (XS604 XPS605 ,XP8), need release 2 snaps of Front Panel & 2 snaps of bottom cabinet , then gently pull the Panel out from the set. (Figure 3)

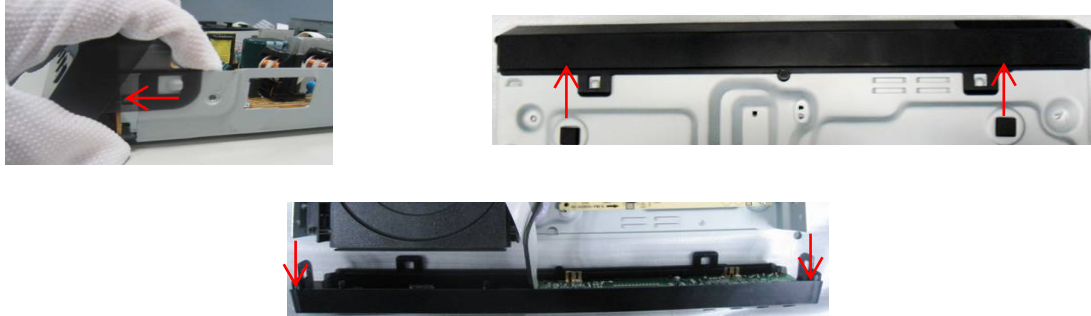

Figure 3

Step4 : Dismantle Front Control Board,remove 5 screws (Figure 4)

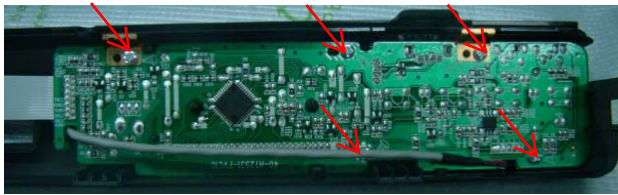

Figure 4

Step5: Dismantle Loader, disconnect the 3 connectors (XP10, XP7,XP5) aiming in the below figure, and remove 2 screws that connects the loader and the bottom cabinet. (Figure 5)



Figure 5

Mechanical and Dismantling Instructions

Dismantling Instruction

Detailed information please refer to the model set.

Step6: Dismantle Main Board, first disconnect 3 connector (XP13), and then remove 7screws. (Figure5/6)

Step7: Dismantle Power Board, disconnect the connectors CN531,CN502,then remove 3 screws.(Figure 5/6)

Step8: Dismantle Amplifier Board, first disconnect connectors(XP702,XP703),and then remove 5 screws (Figure 5/6)

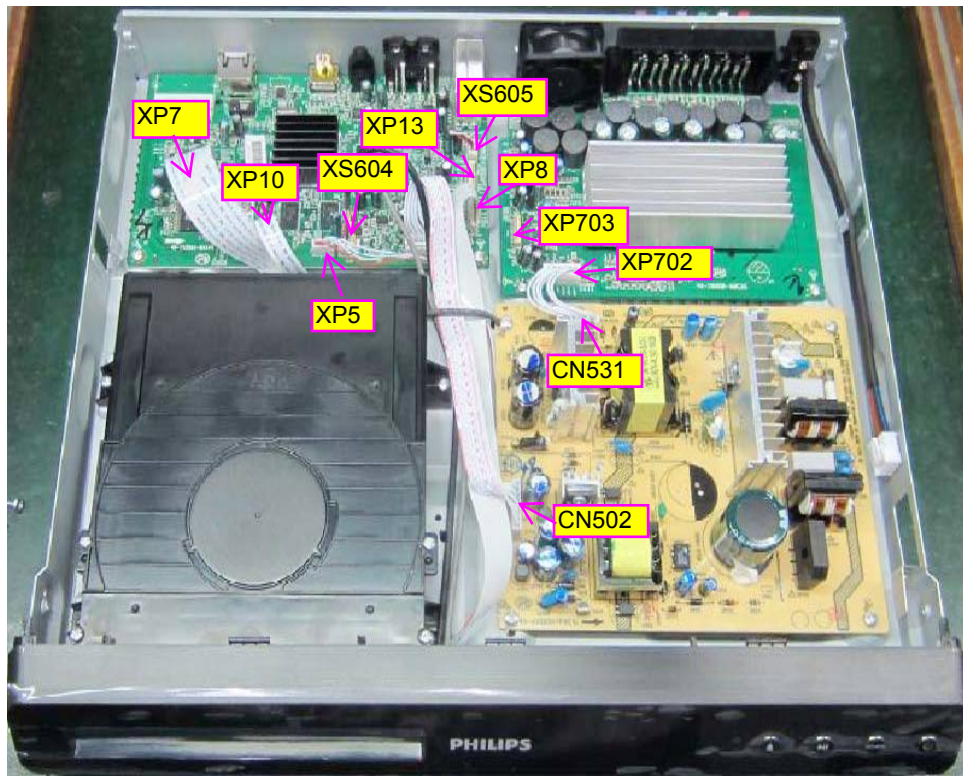

Figure 6

Software upgrade

Software upgrade method:

1. Copy the bin file as "HTS3592M2_XX.bin".
2. Then use the file to burn the upgrade CD-R/CD-RW.
3. Put the CD in the tray ,let the player loading the disc.
4. If the CD is correct ,it will display the Upgrade Menu ,press the PLAY key on the remote control to start upgrade
5. After a while, the tray will open automatically ,but must not power off the player.
6. Don't power off ,wait until the player reset automatically ,the whole upgrade process may need 2 minutes .HTS will auto standby after complete upgrade.

if you upgrade with USB device:

1. step1 is same with DISC upgrade;
2. Copy the renamed bin file(upgrade file) to the root menu of USB device.
3. connect the USB device to HTS ,and switch to USB source;
4. The rest is same to step 4, step 5 and step 6 with DISC upgrade.

Caution: The set must not be power off during upgrading, Otherwise the Main board will be damaged entirely.

VFD No display on Front Control Board

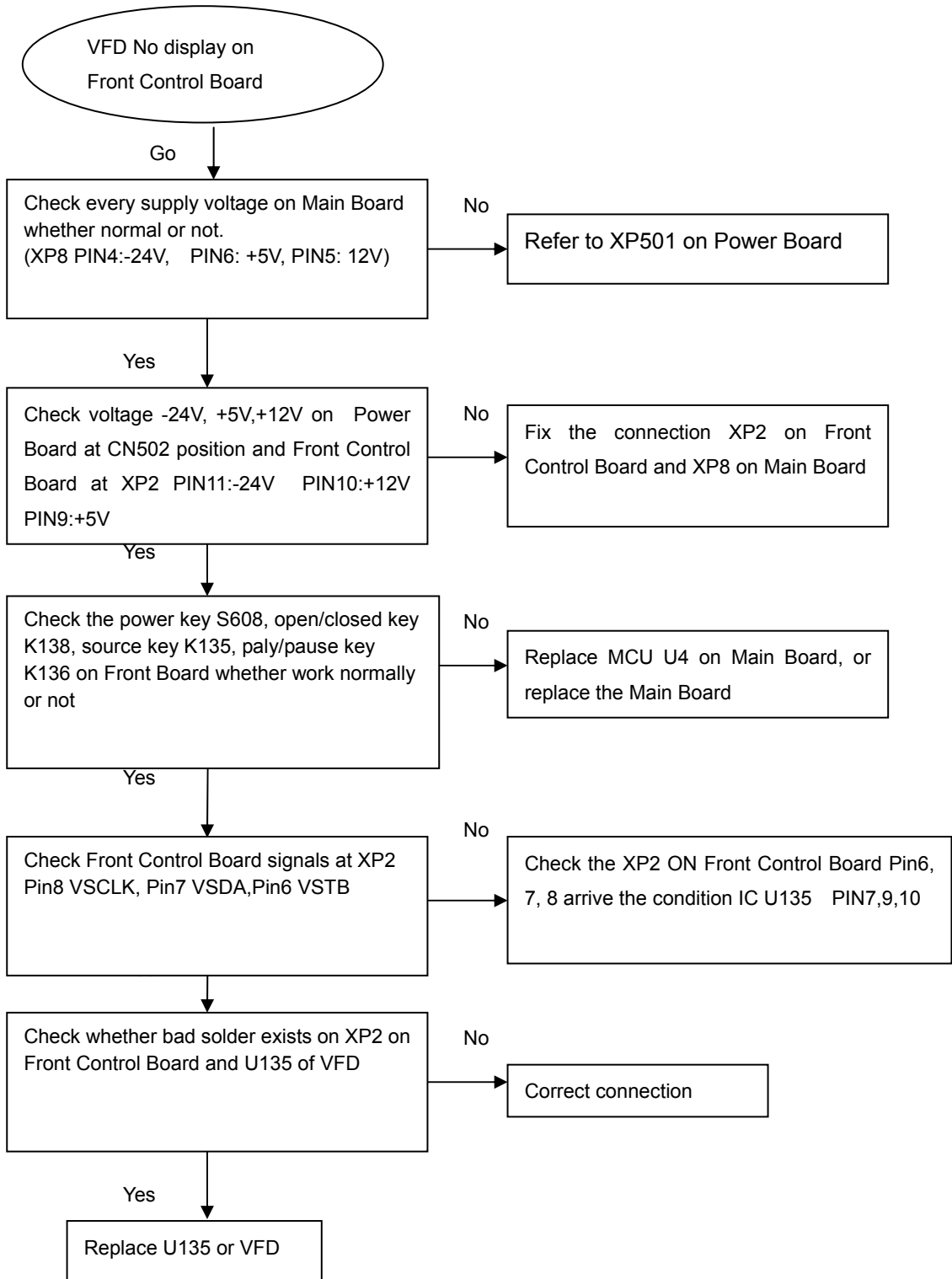

keys do not work

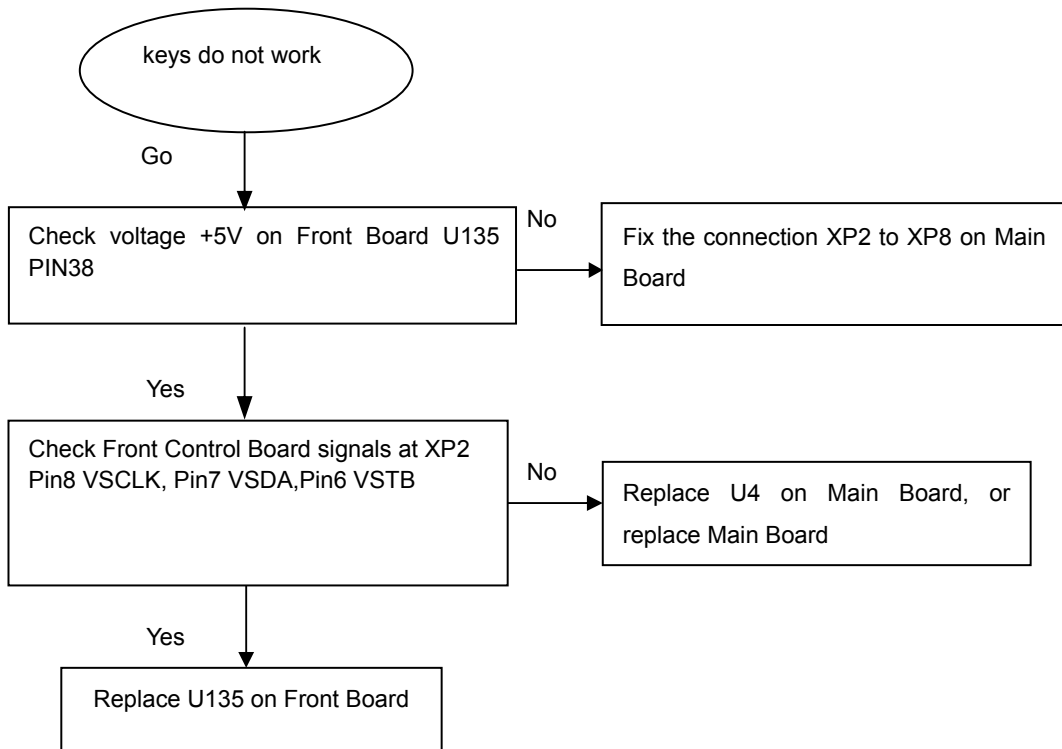

Remote control does not work

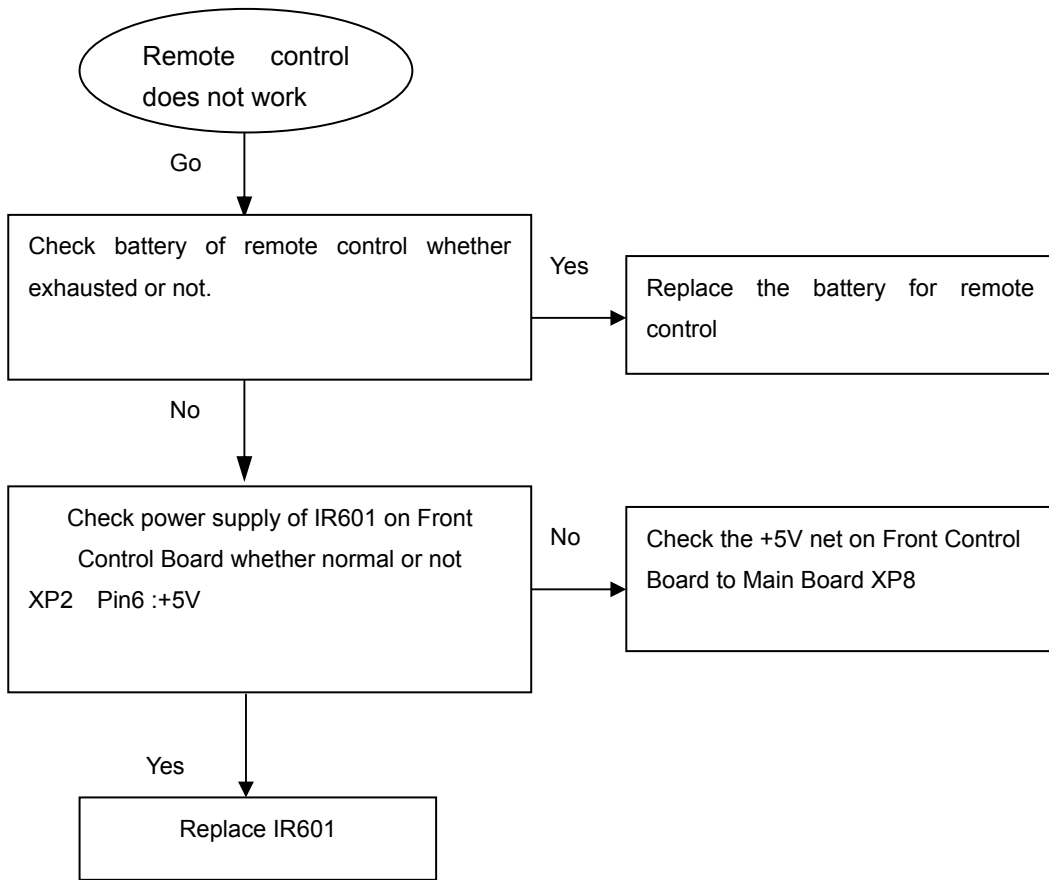

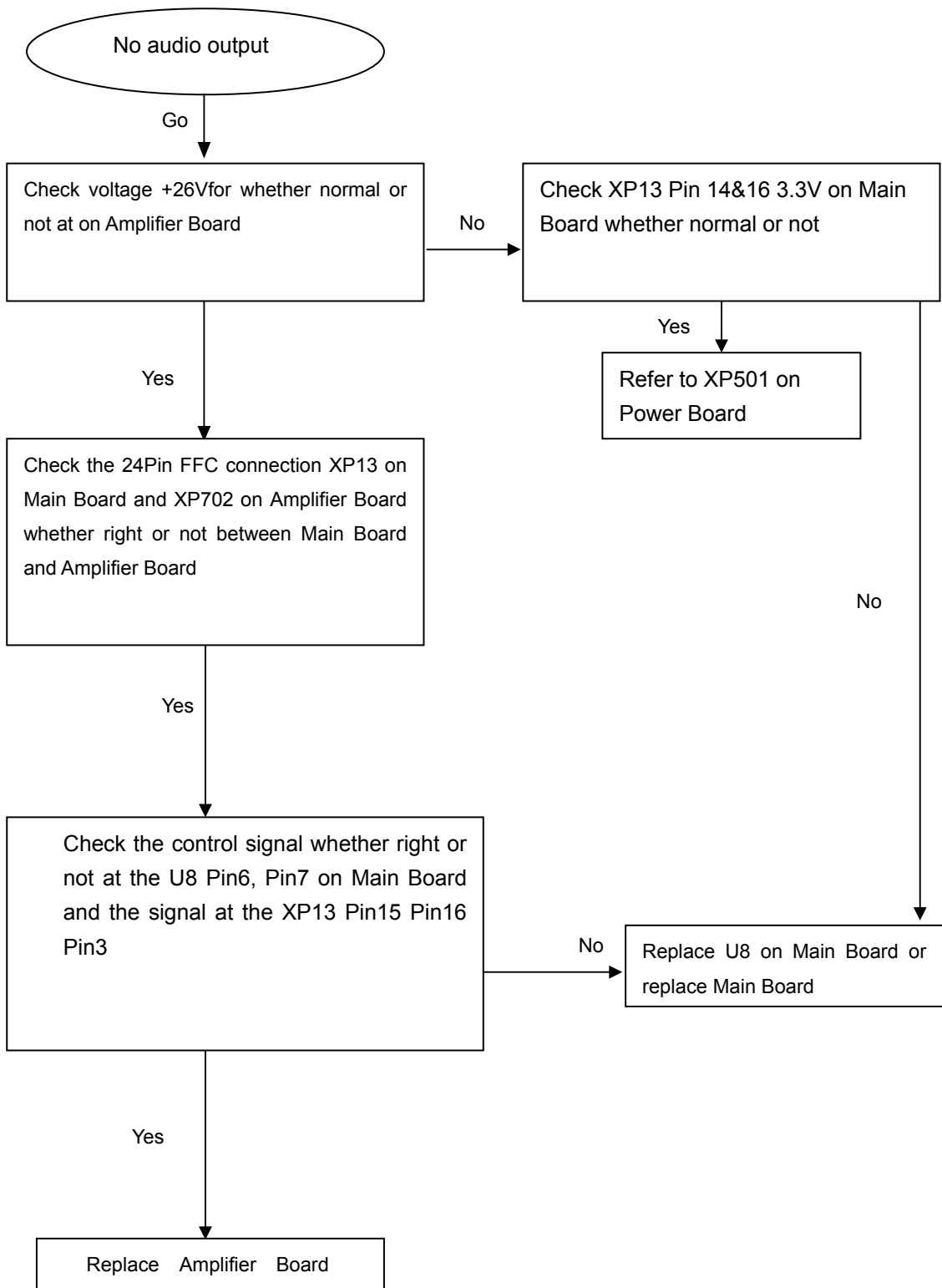
No audio output

No video output

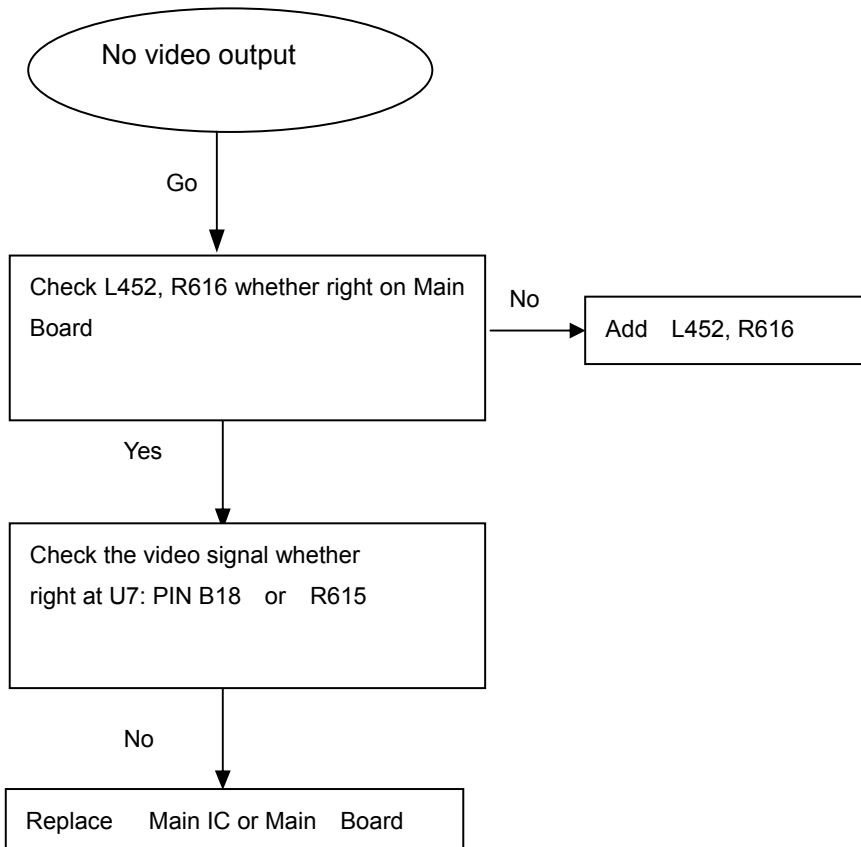

Can't read disc or can't open the disk door

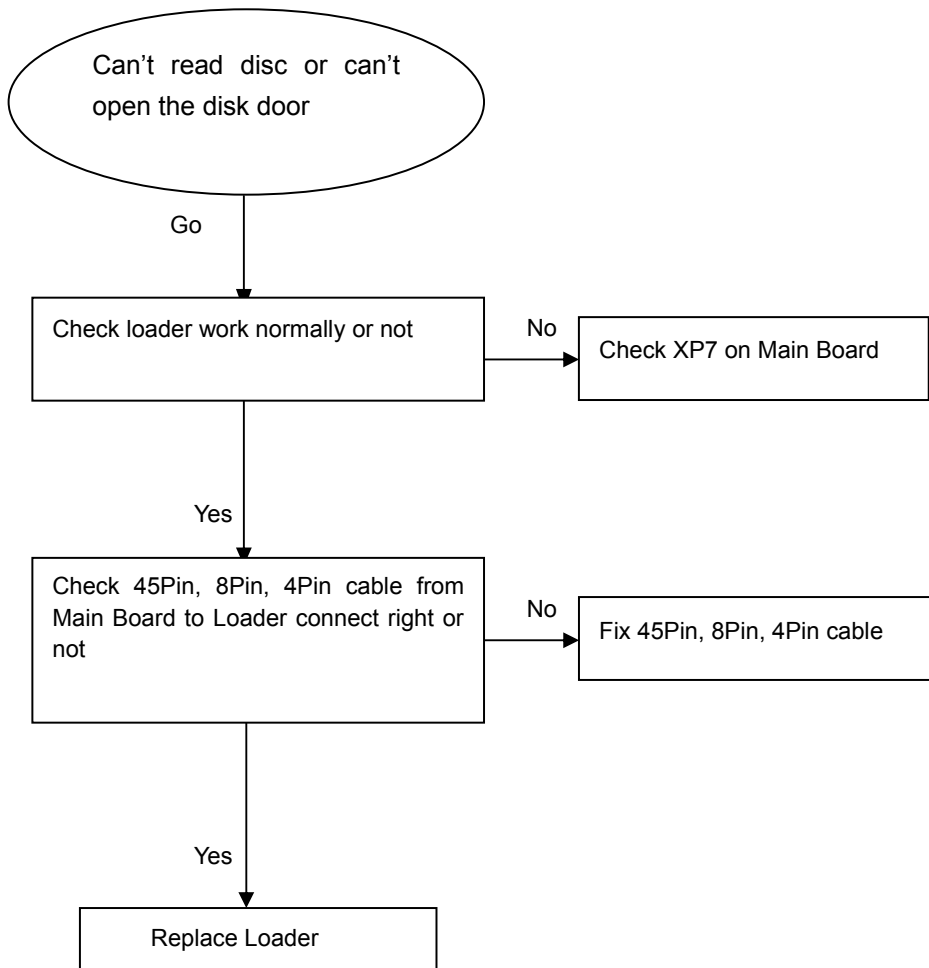

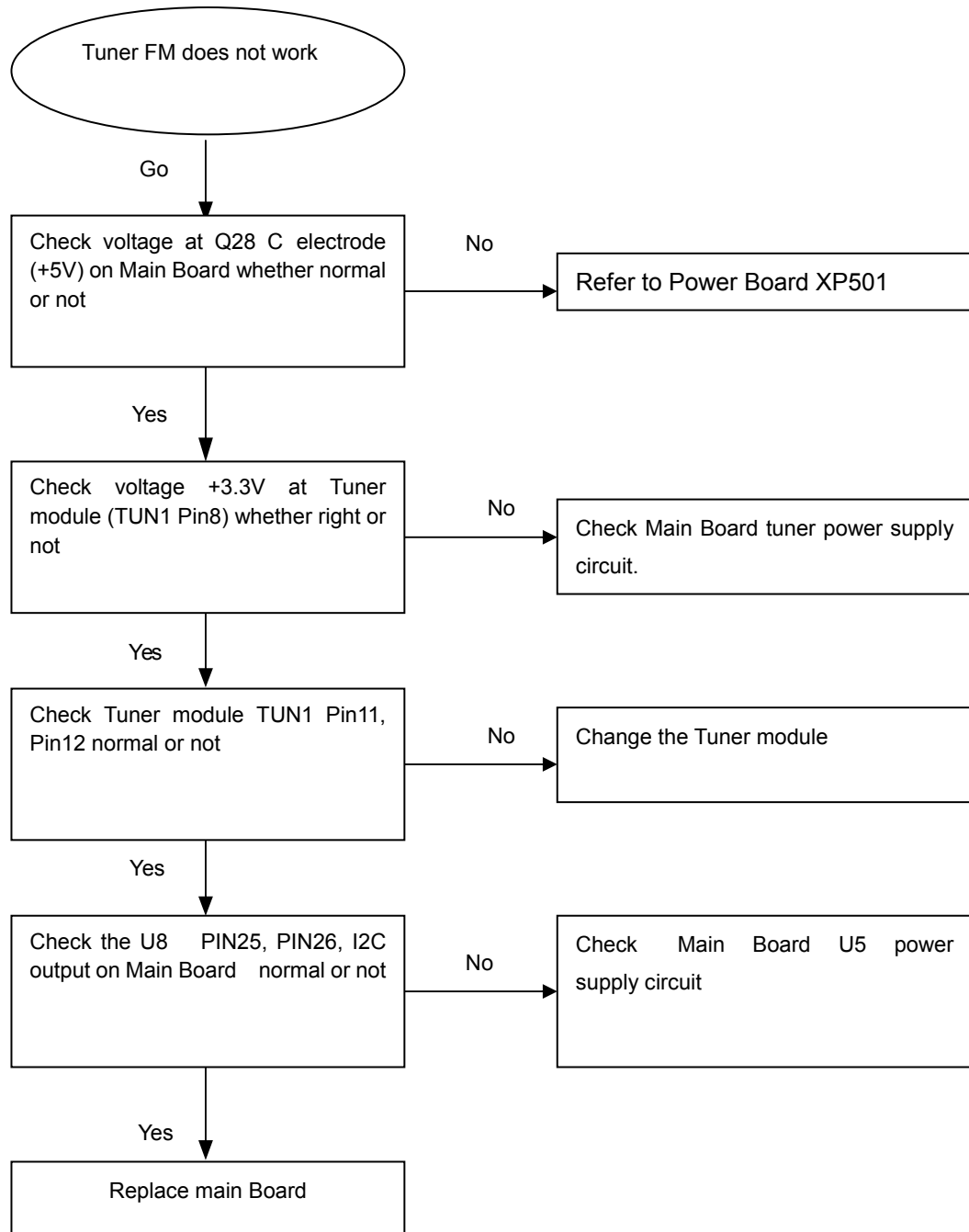
Tuner FM does not work

AUX in does not work

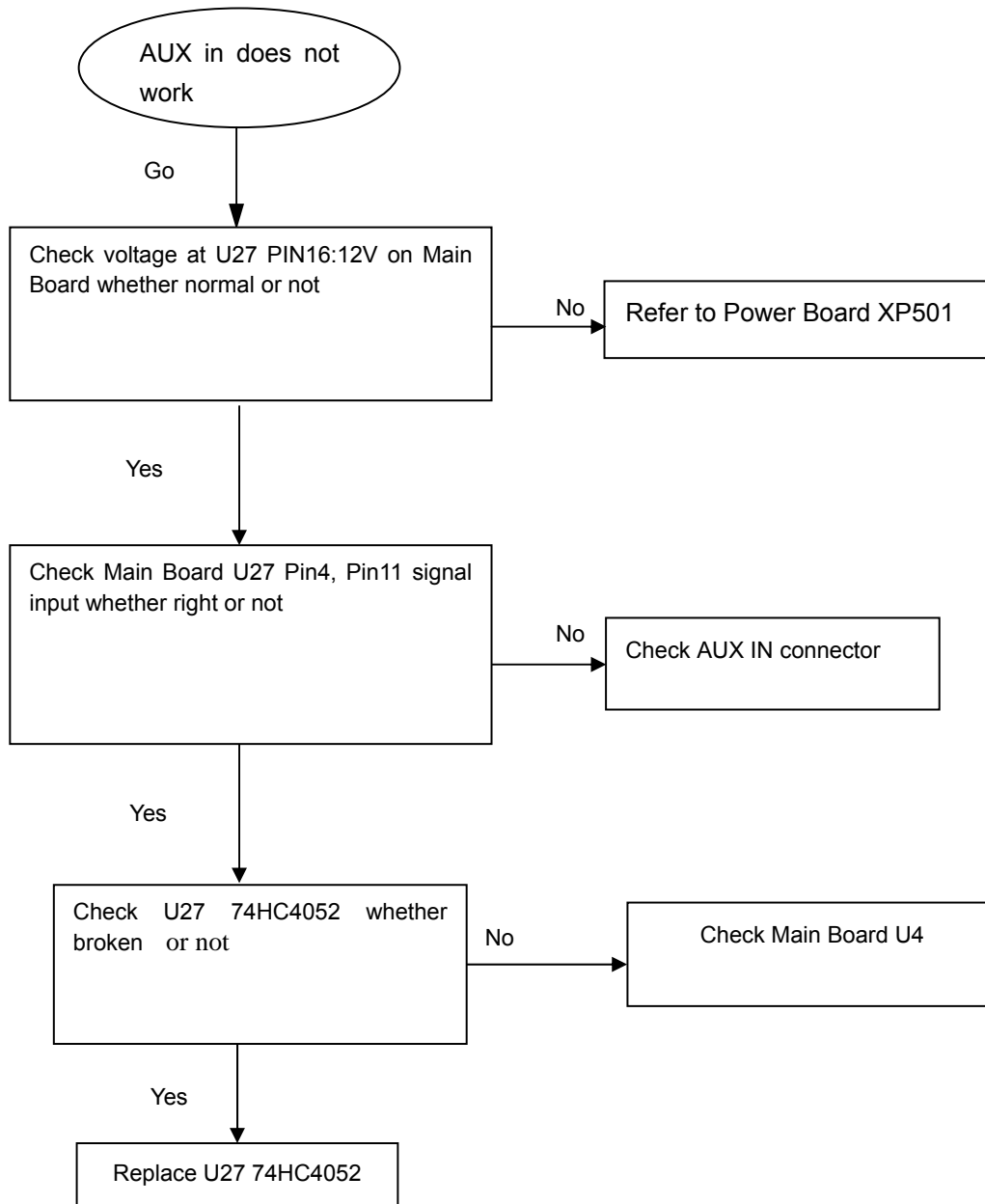

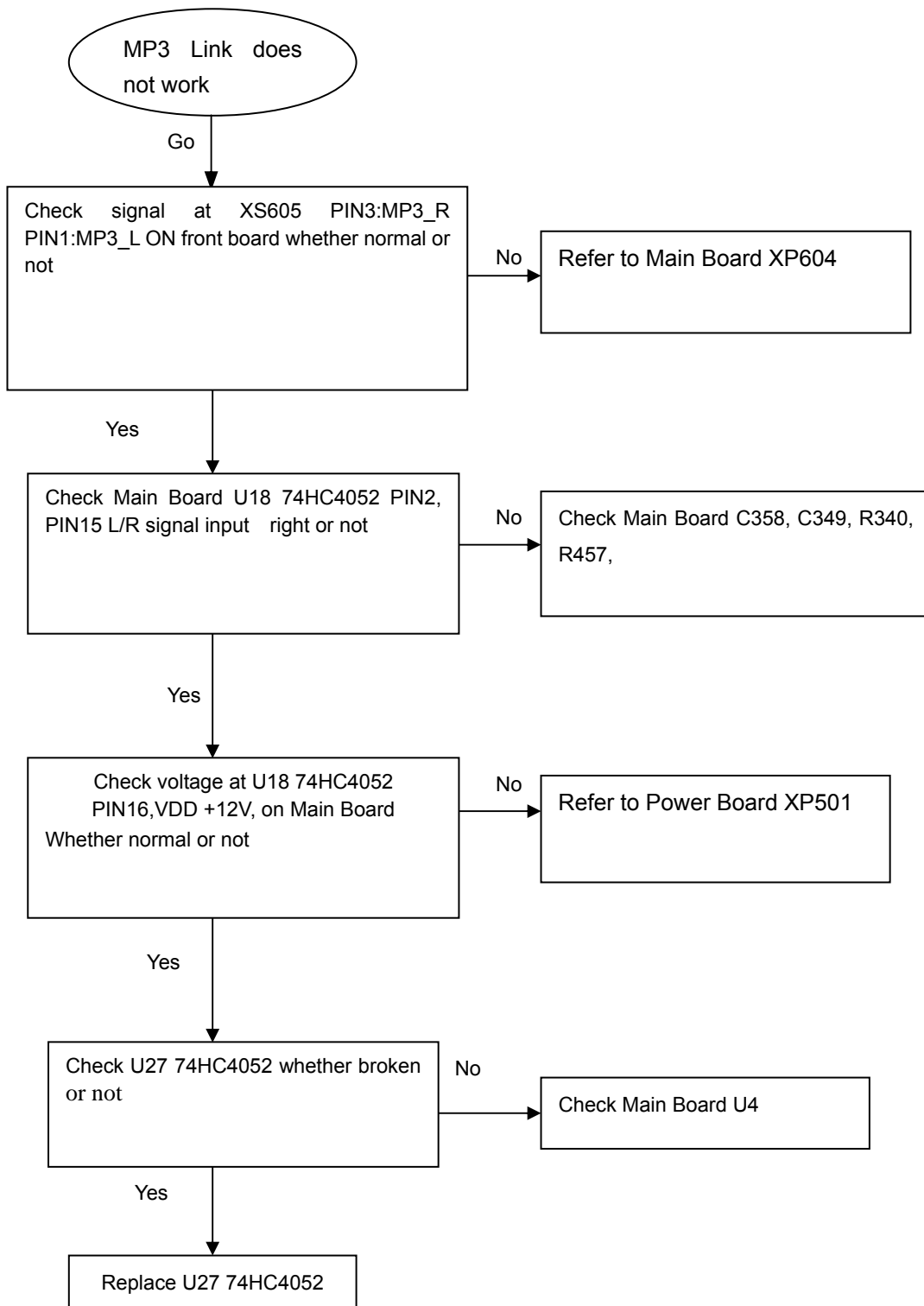
MP3 Link does not work

COAX in does not work

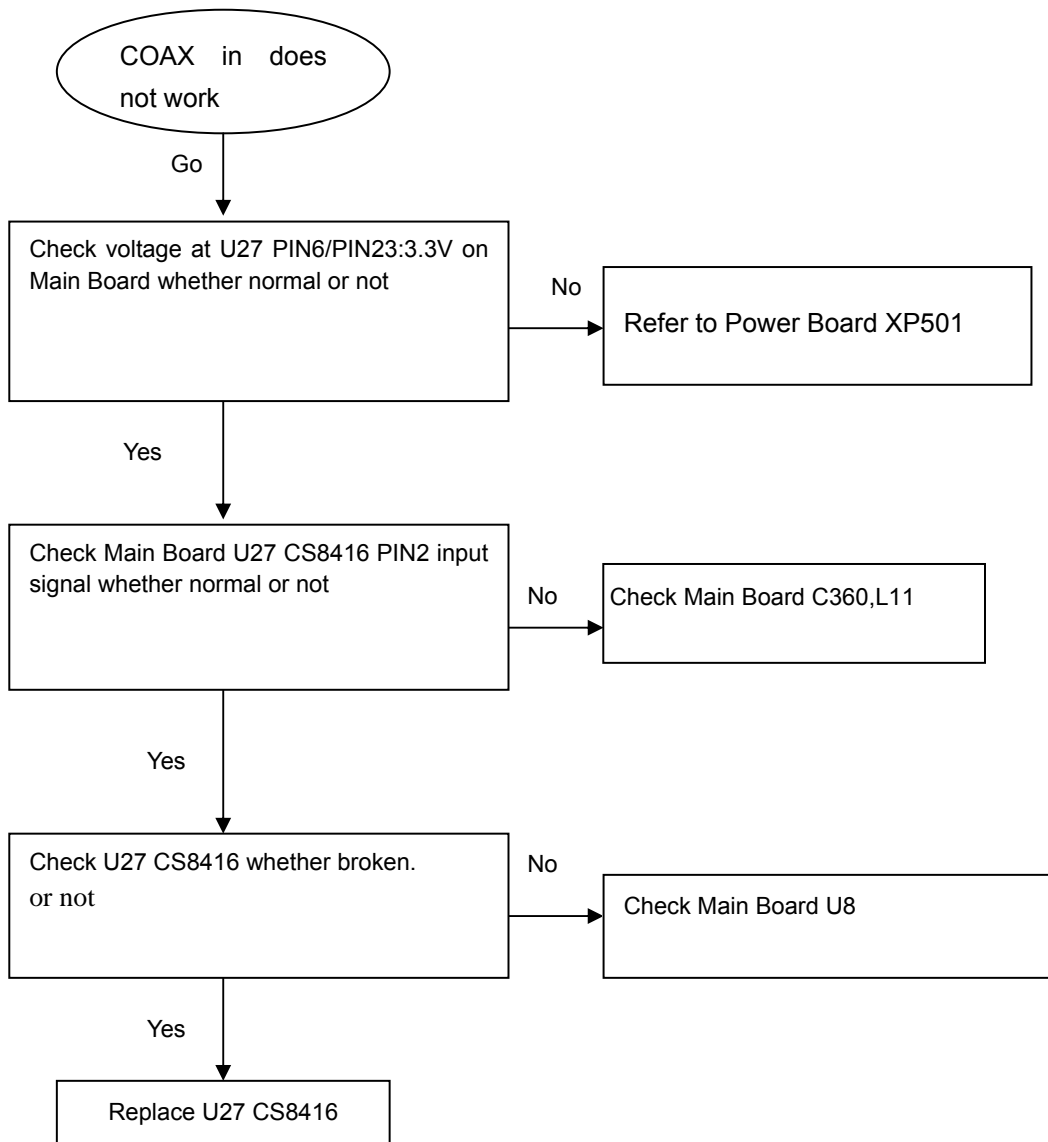

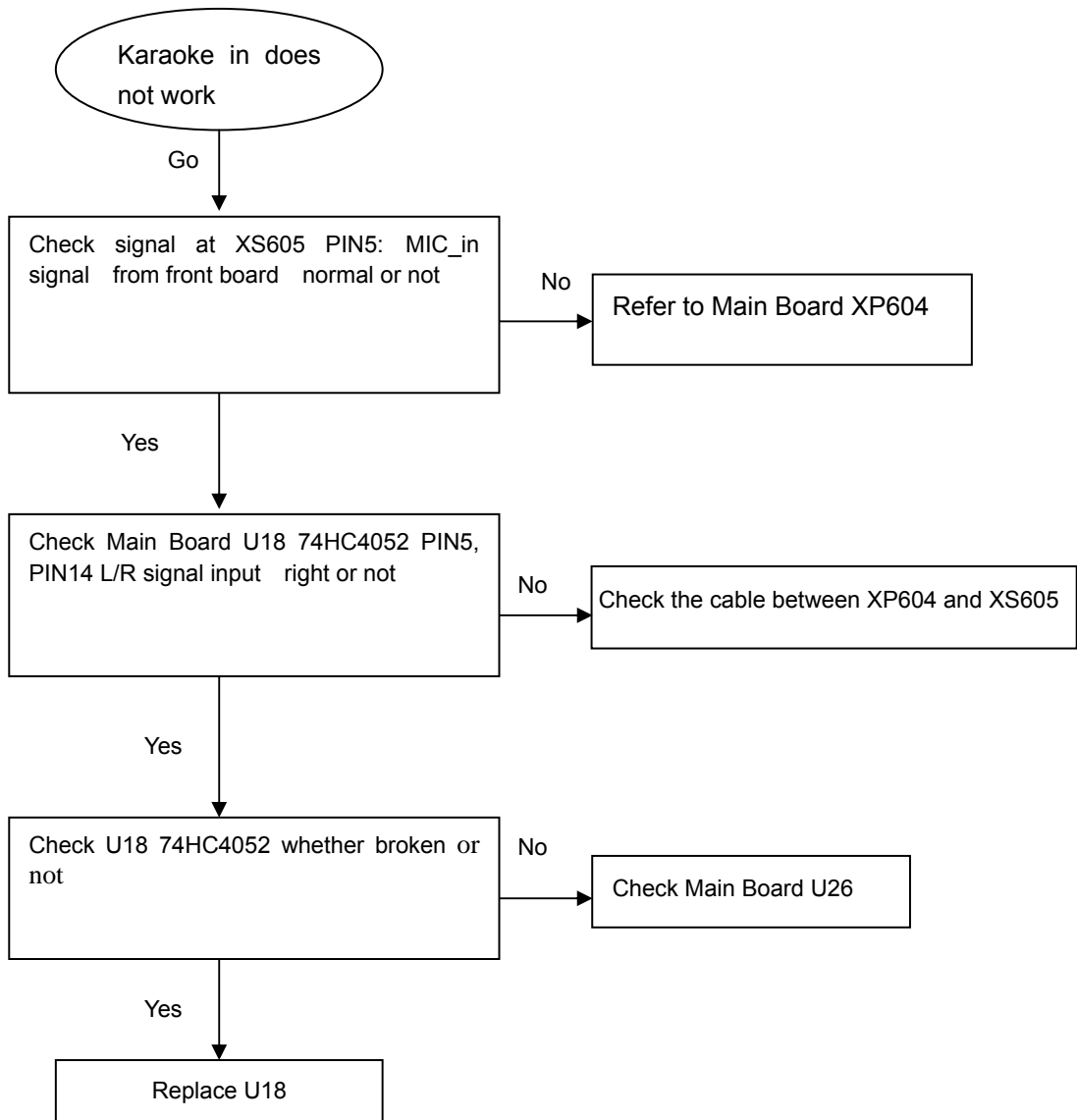
Karaoke in does not work

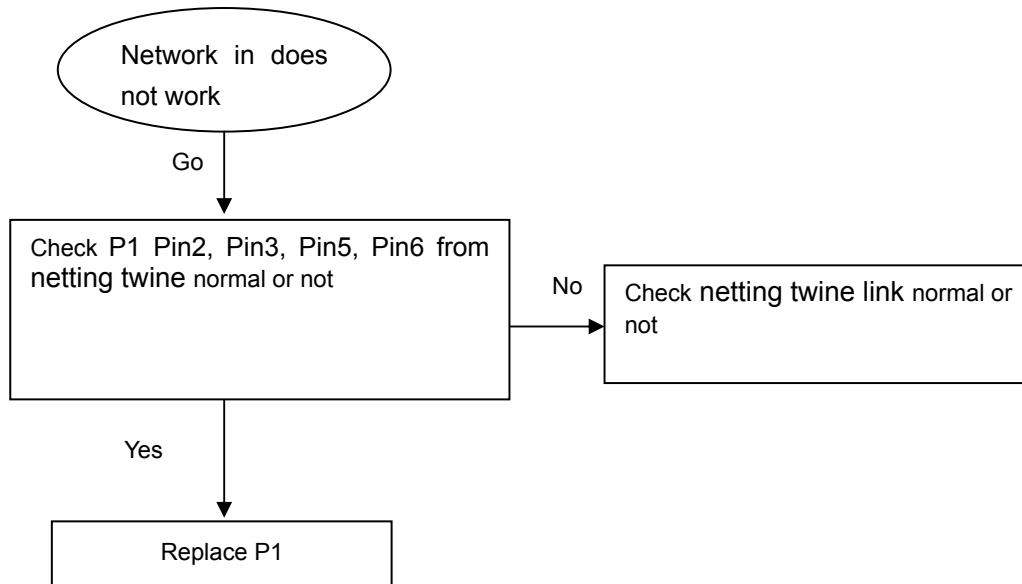
Network in does not work

HTS3592M2/93 Block /Wiring Diagram:

Notes: The differences between HTS3582 & HTS3582M2 are as below (red circle):
 1. Main Board: HTS3582 use IC MT8555, HTS3582M2 use IC MT8560
 2. Loader: HTS3582 use 05-L9829A-414V, HTS3582M2 use 05-L9829B-415

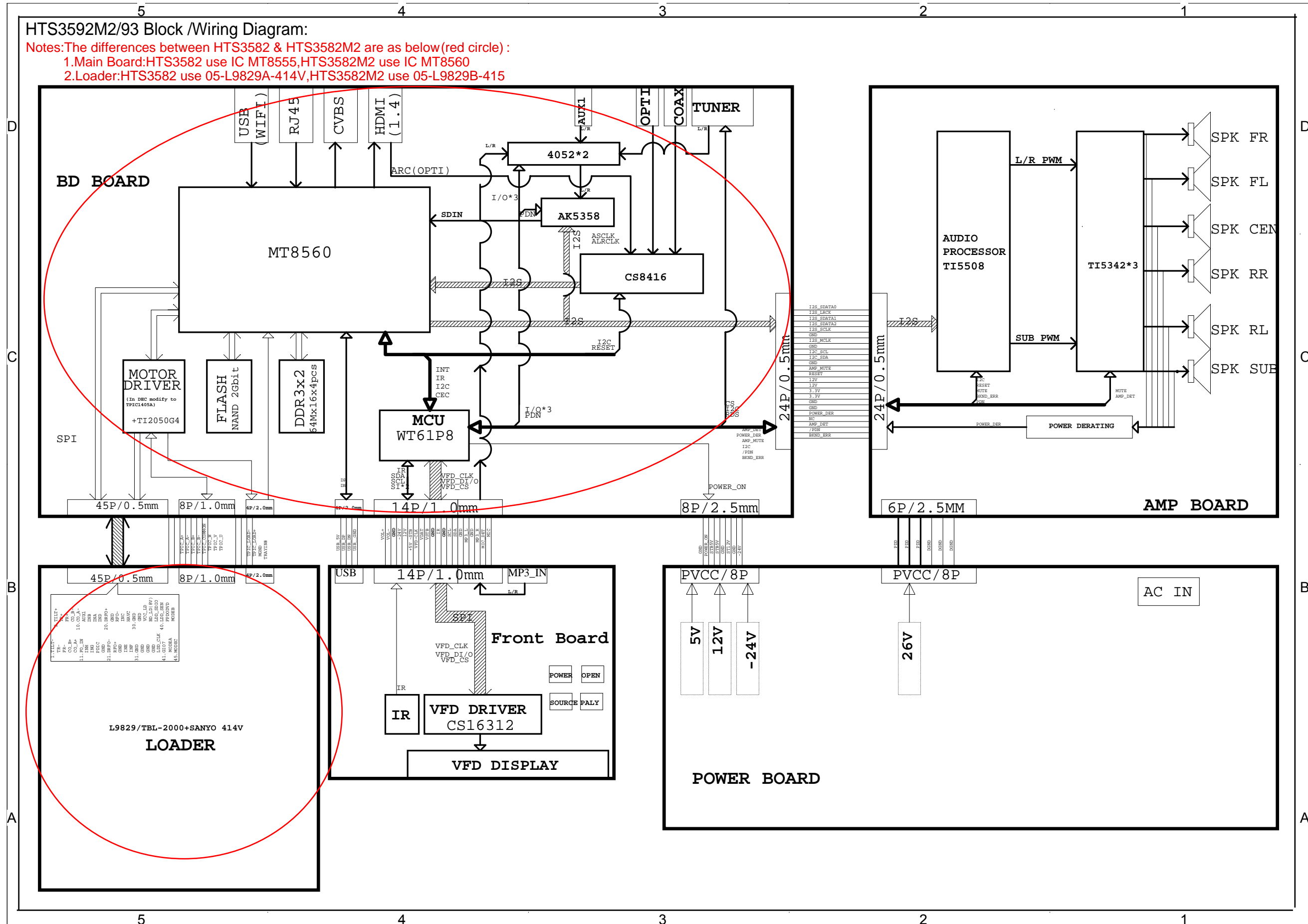

Front Control Board Circuit Diagram for HTS3592M2/93:

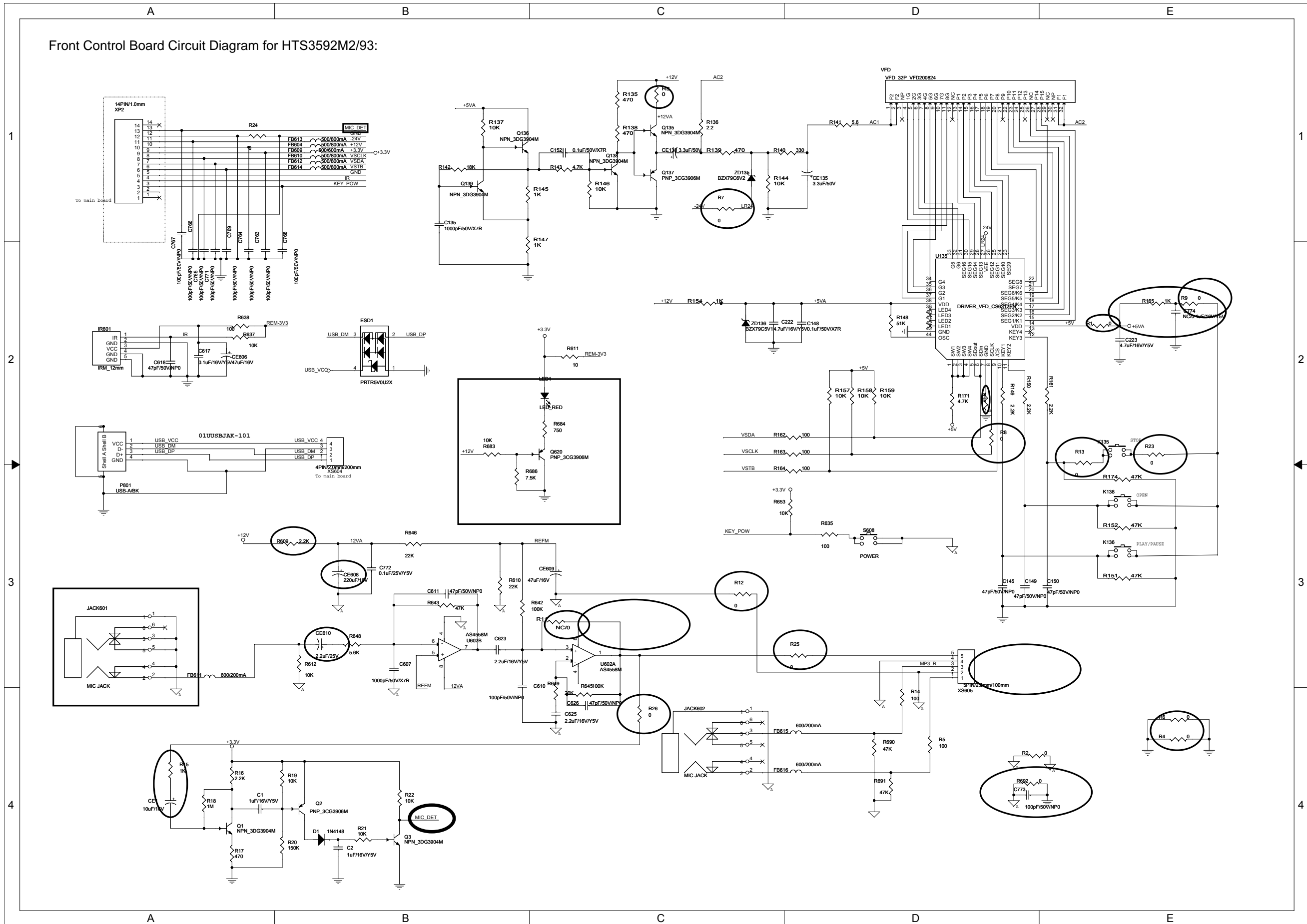

Power Board Circuit Diagram for HTS3592M2/93:

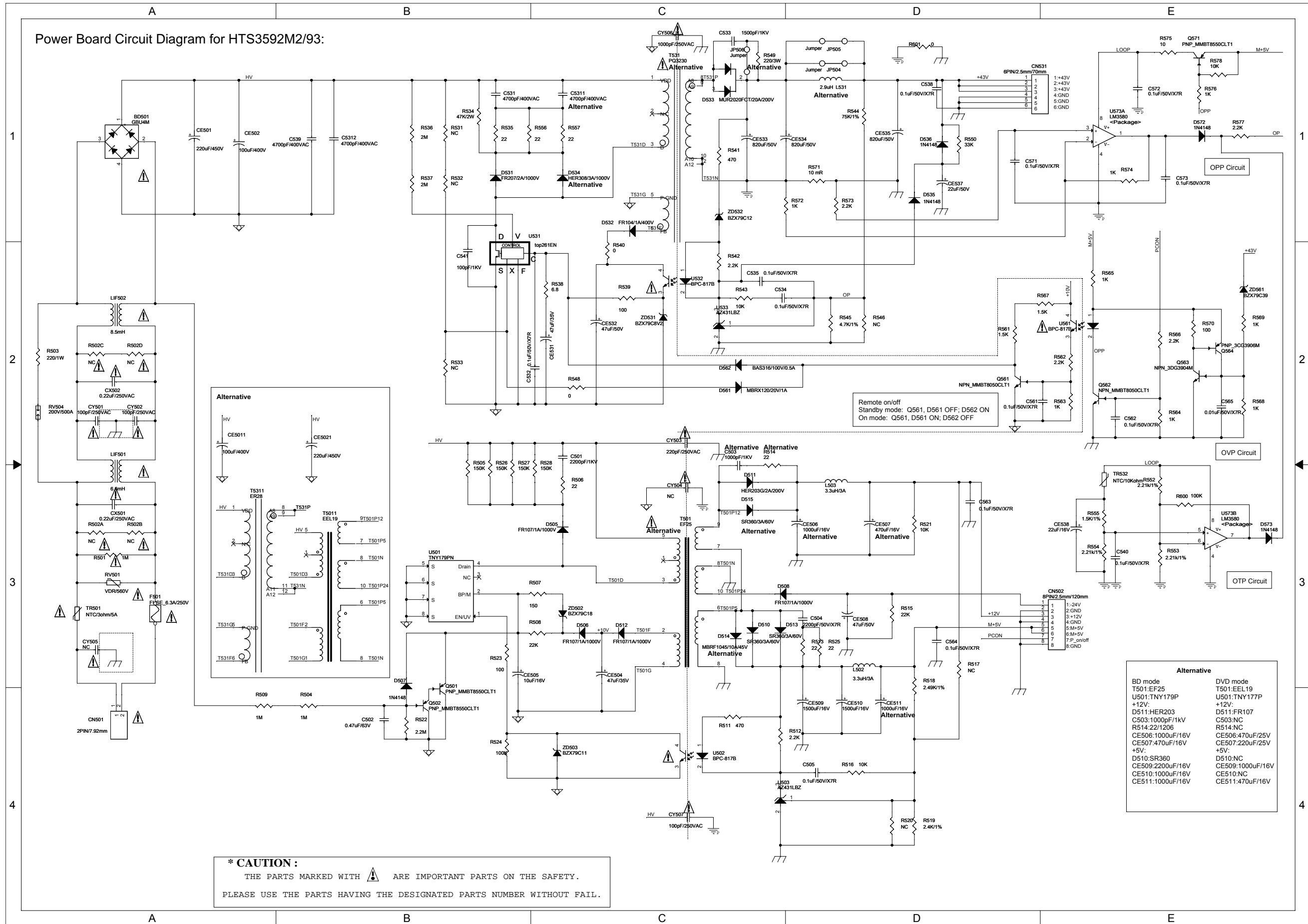

*** CAUTION :**
 THE PARTS MARKED WITH  ARE IMPORTANT PARTS ON THE SAFETY.
 PLEASE USE THE PARTS HAVING THE DESIGNATED PARTS NUMBER WITHOUT FAIL.

Alternative	
BD mode	DVD mode
T501:EF25	T501:EEL19
U501:TNY179P	U501:TNY177P
+12V:	+12V:
D511:HER203	D511:FR107
C503:1000pF/1K	C503:NC
R514:22/1206	R514:NC
CE506:1000uF/16V	CE506:470uF/25V
CE507:470uF/16V	CE507:220uF/25V
+5V:	+5V:
D510:SR360	D510:NC
CE509:2200uF/16V	CE509:1000uF/16V
CE510:1000uF/16V	CE510:NC
CE511:1000uF/16V	CE511:470uF/16V

Amplifier Board Circuit Diagram for HTS3592M2//93:DSP

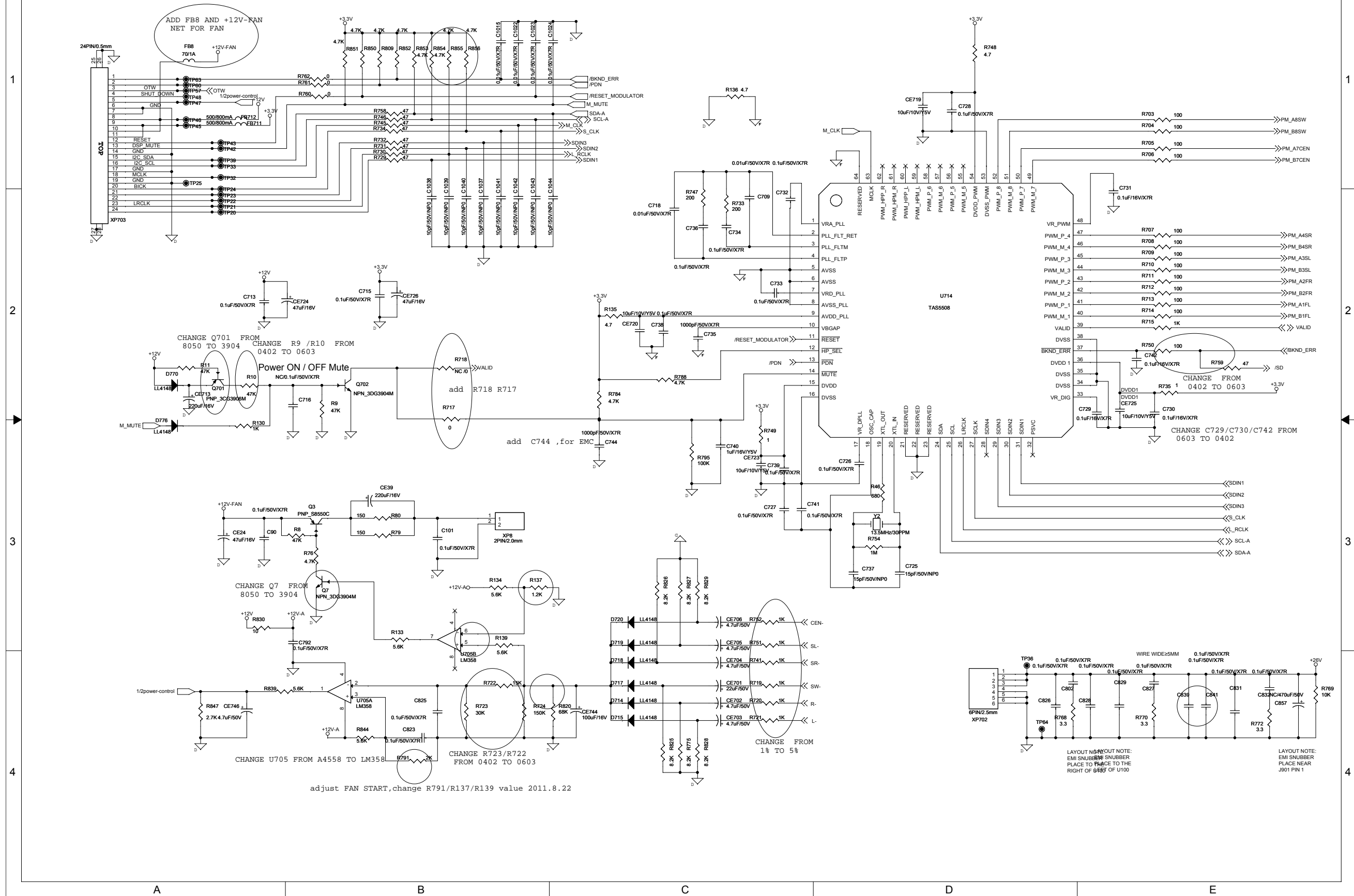

Amplifier Board Circuit Diagram HTS3592M2/93:SL+SW

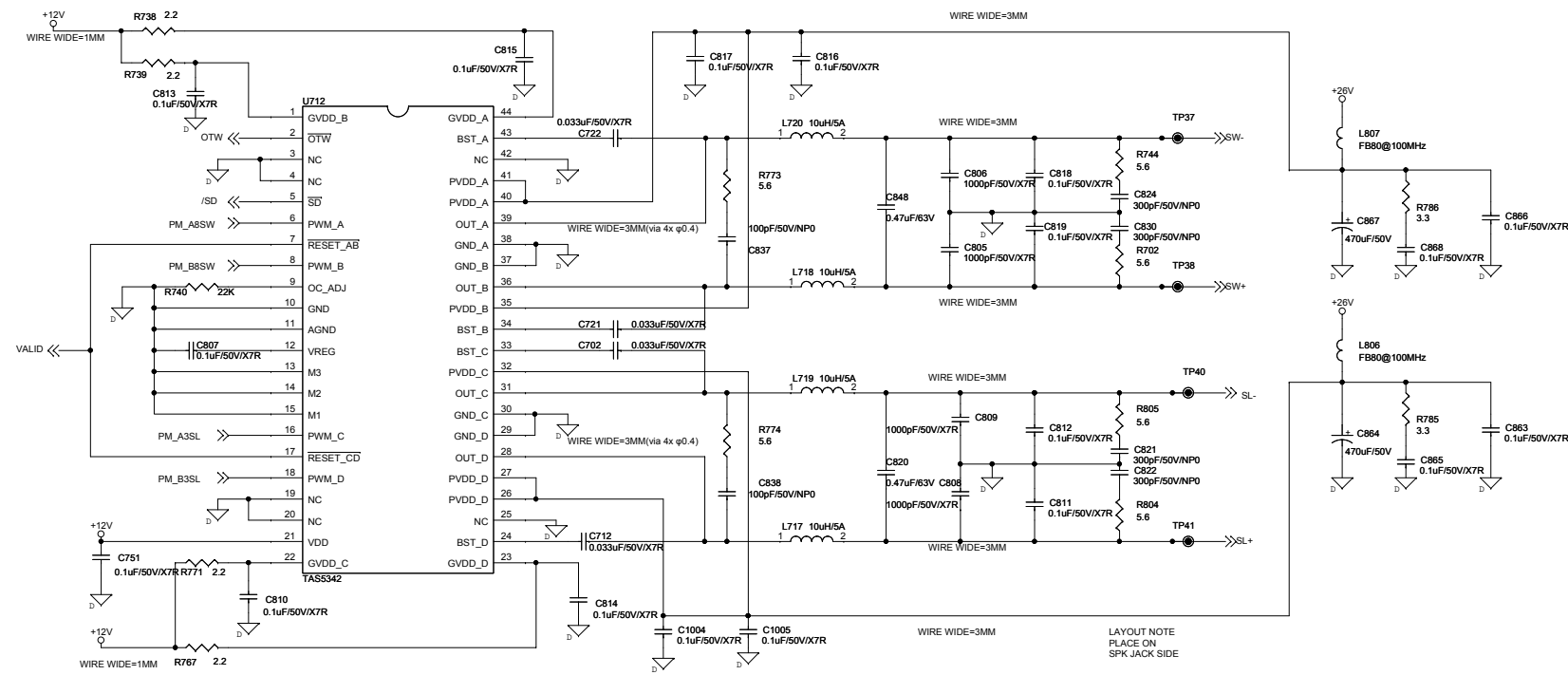

Main Board Circuit Diagram for HTS3592M2/93:Power Source

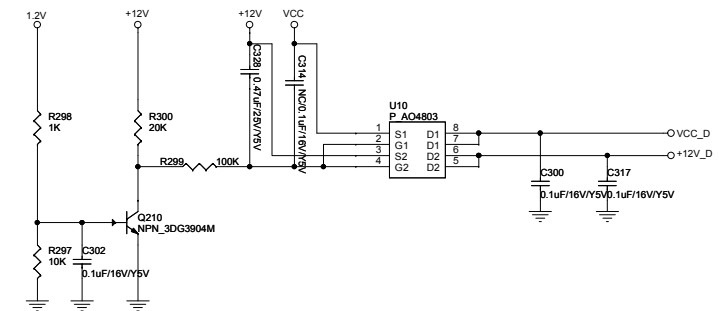
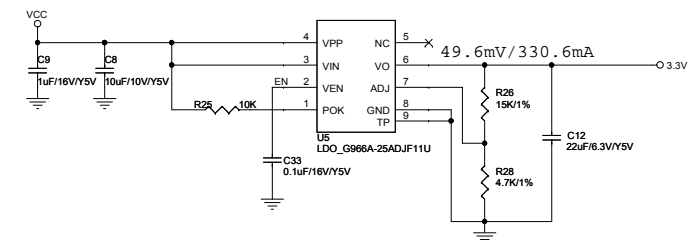
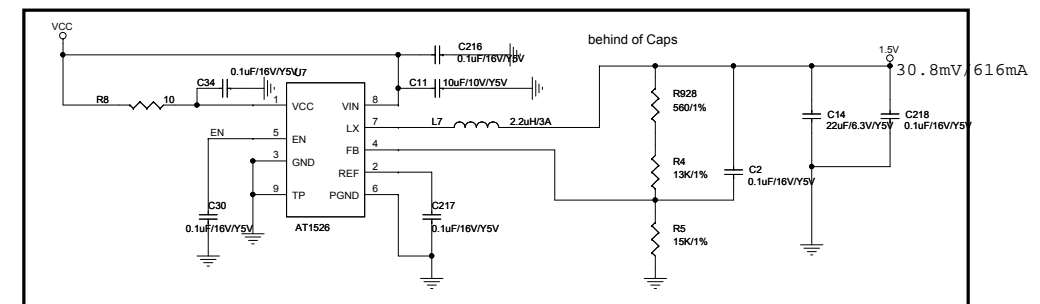
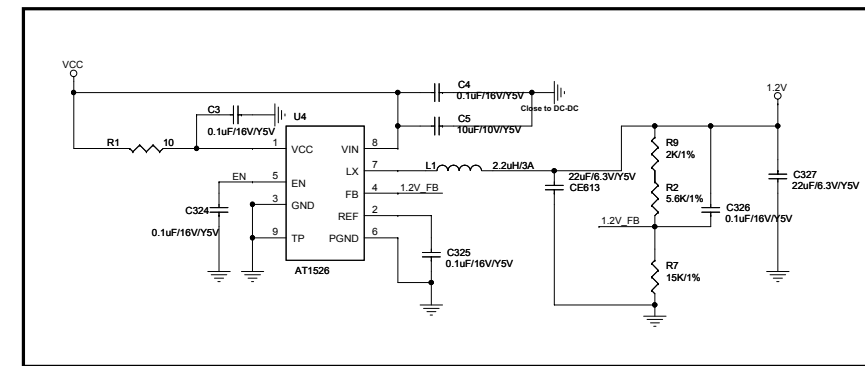
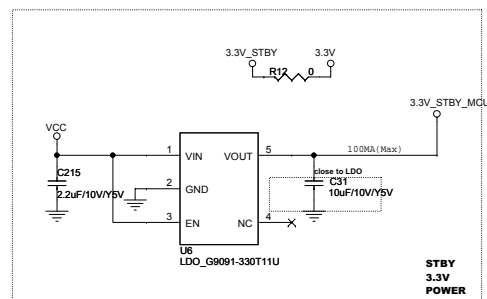
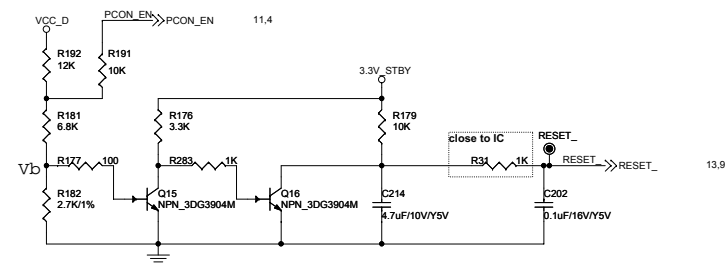
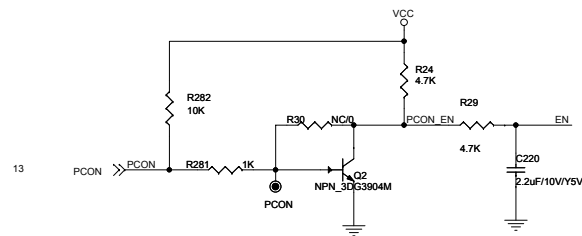
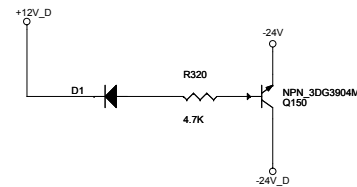
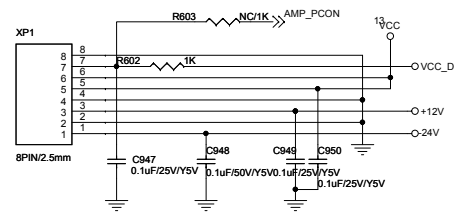

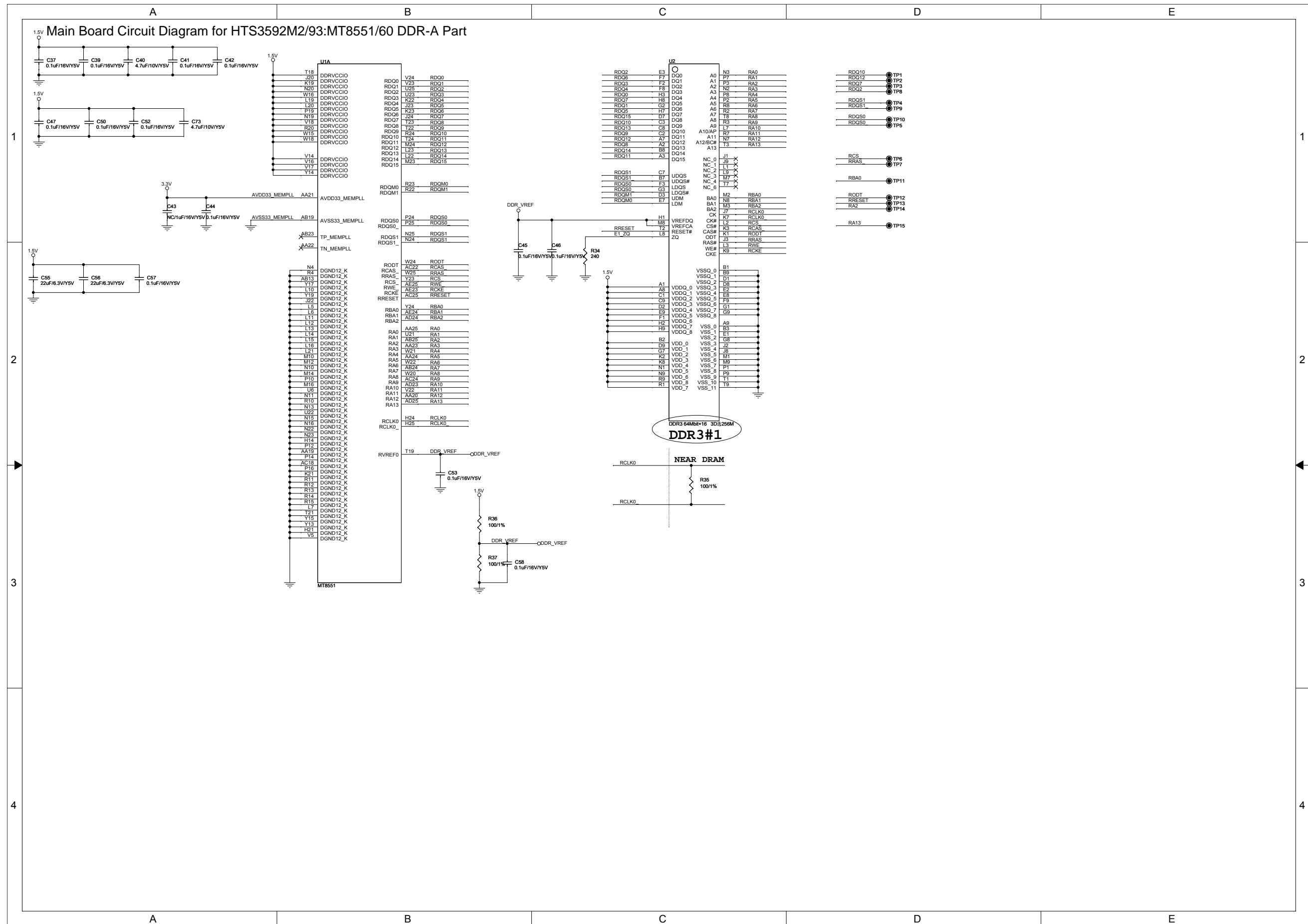

Main Board Circuit Diagram for HTS3592M2/93:MT8551/60 DDR-B Part

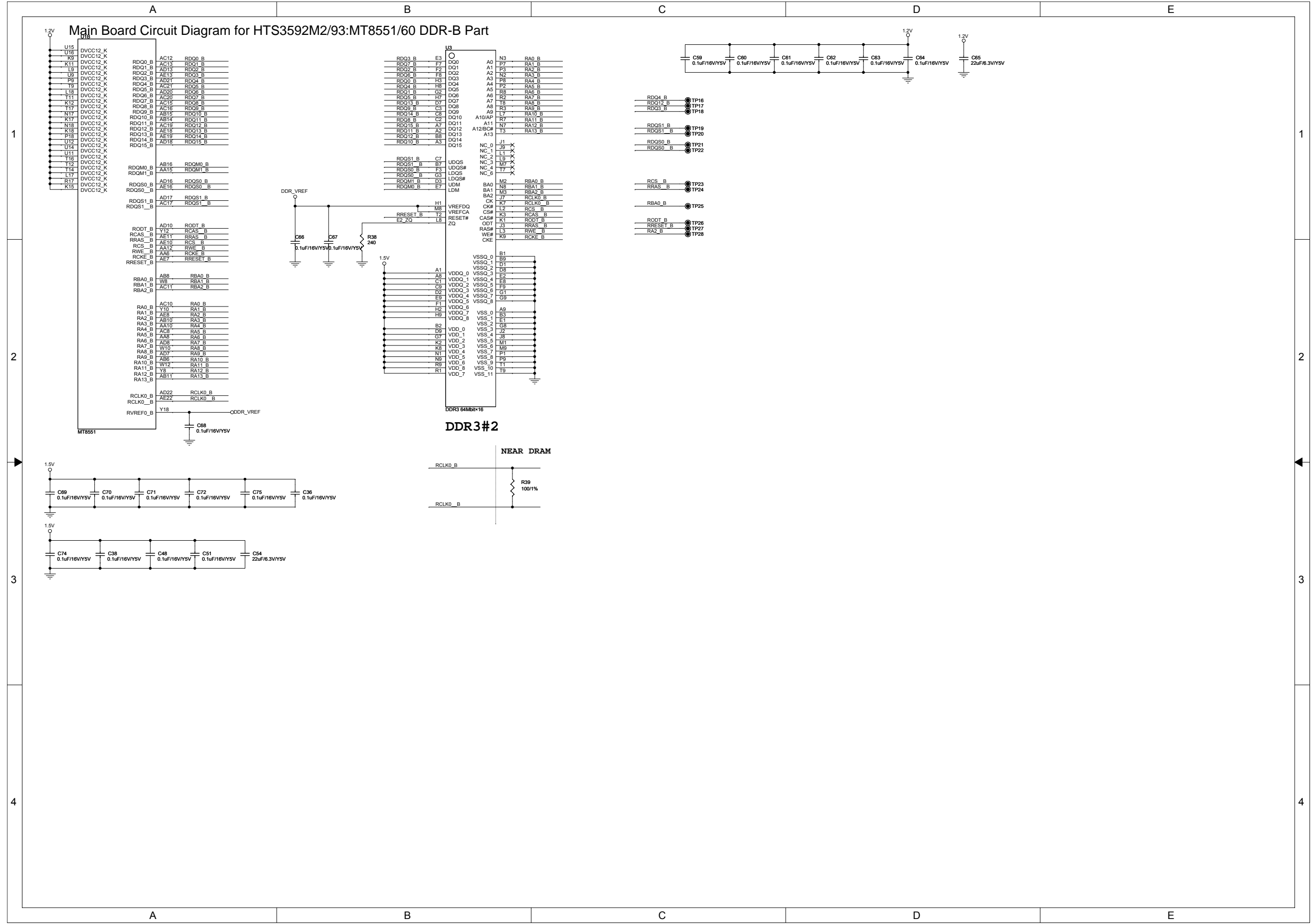

Main Board Circuit Diagram for HTS3592M2/93:MT8551/60-AV/PLL

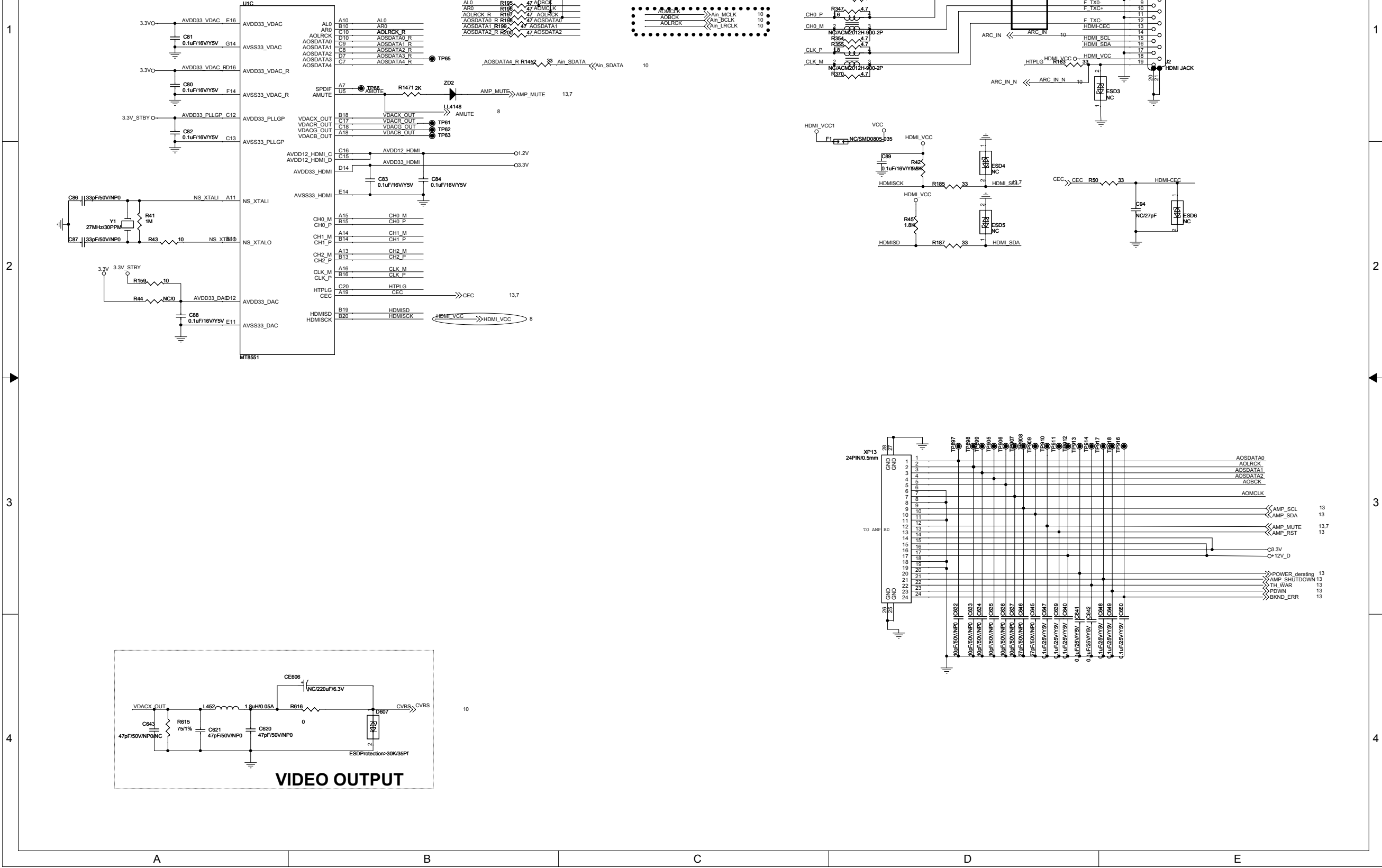

Main Board Circuit Diagram for HTS3592M2/93:MT8551/60-MCU

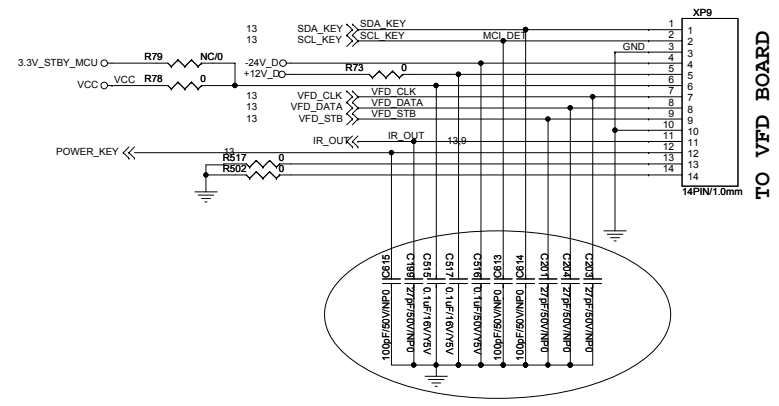
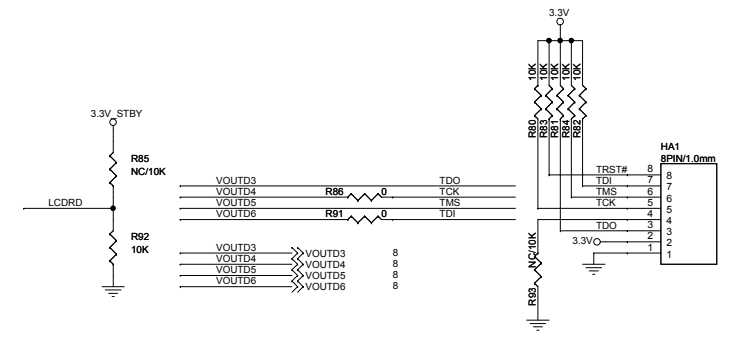
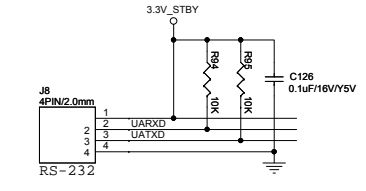
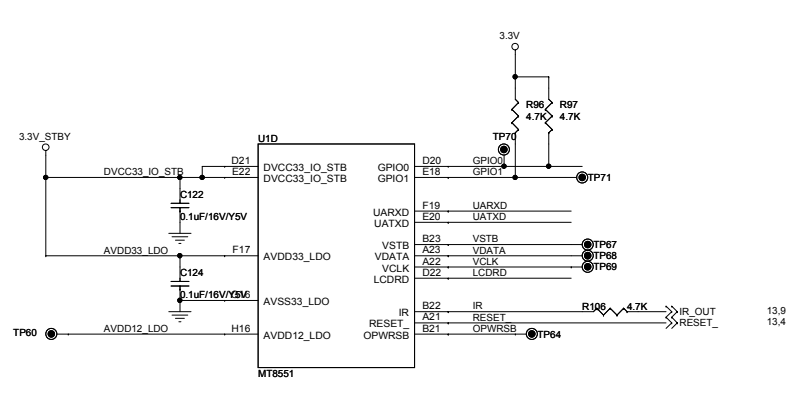

Main Board Circuit Diagram for HTS3592M2/93:Audio in

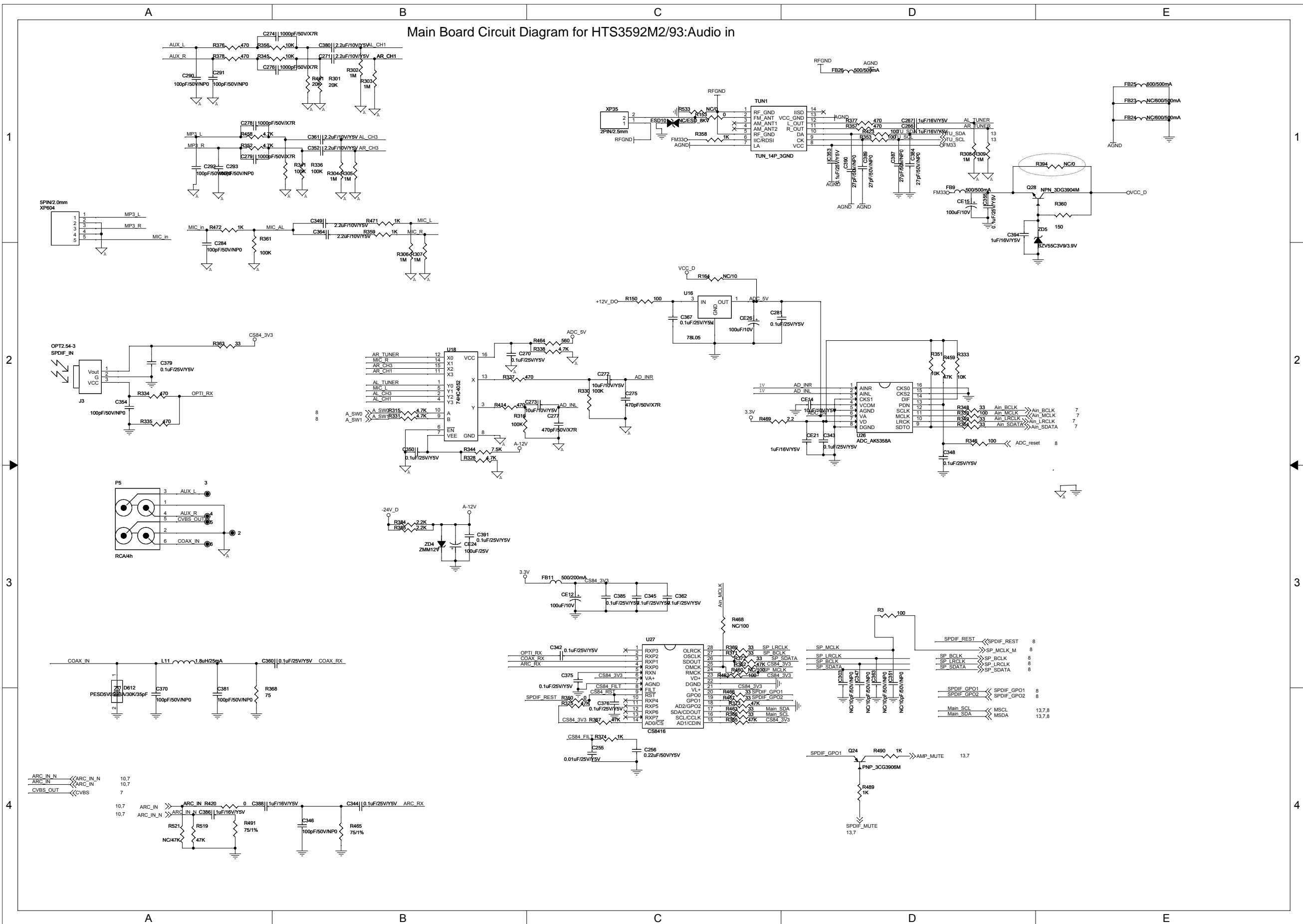

Main Board Circuit Diagram for HTS3592M2/93:MT8551/60-FE

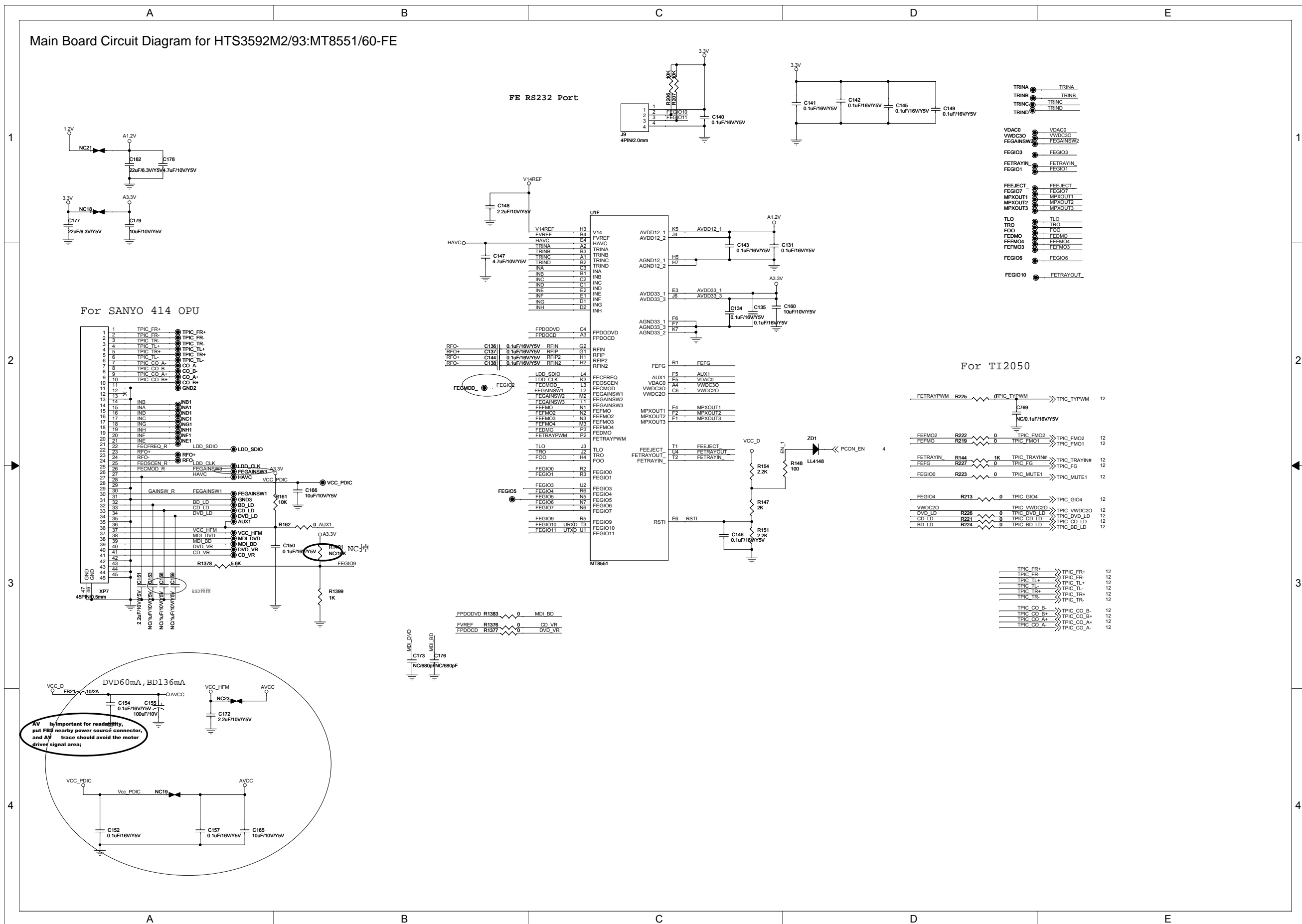

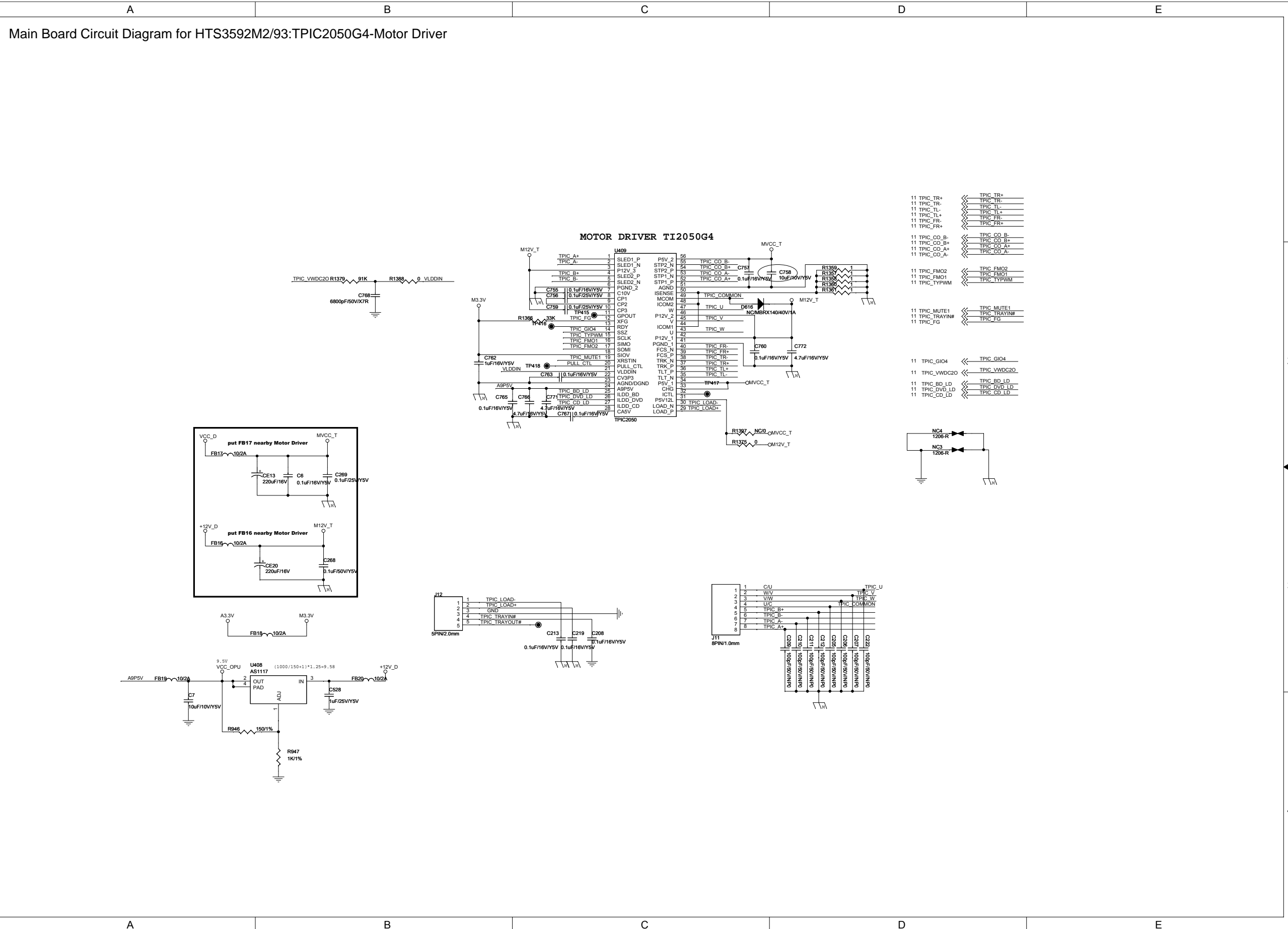

Main Board Circuit Diagram for HTS3592M2/93:MCU

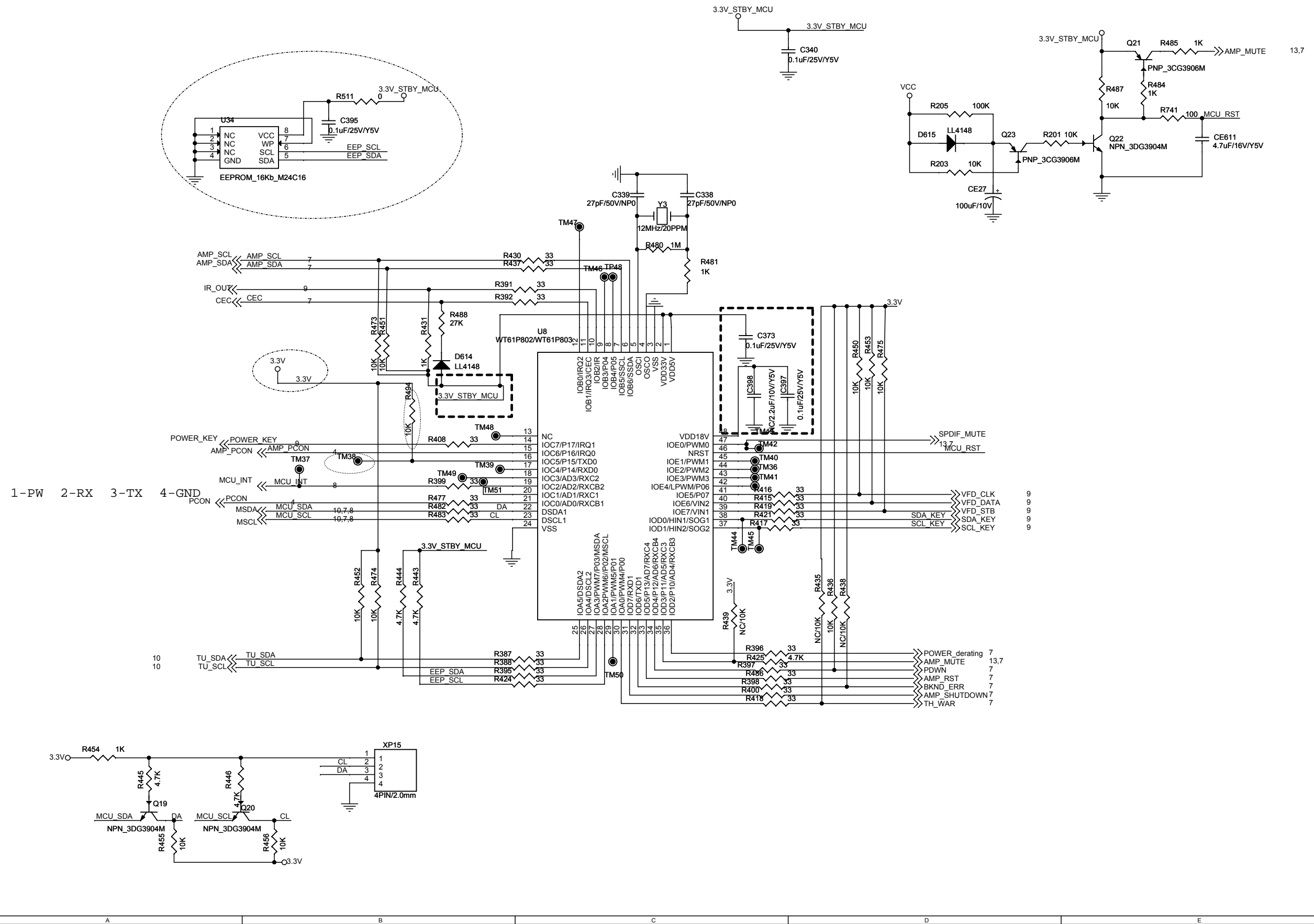

Front Control Board Print-layout for HTS3592M2/93:

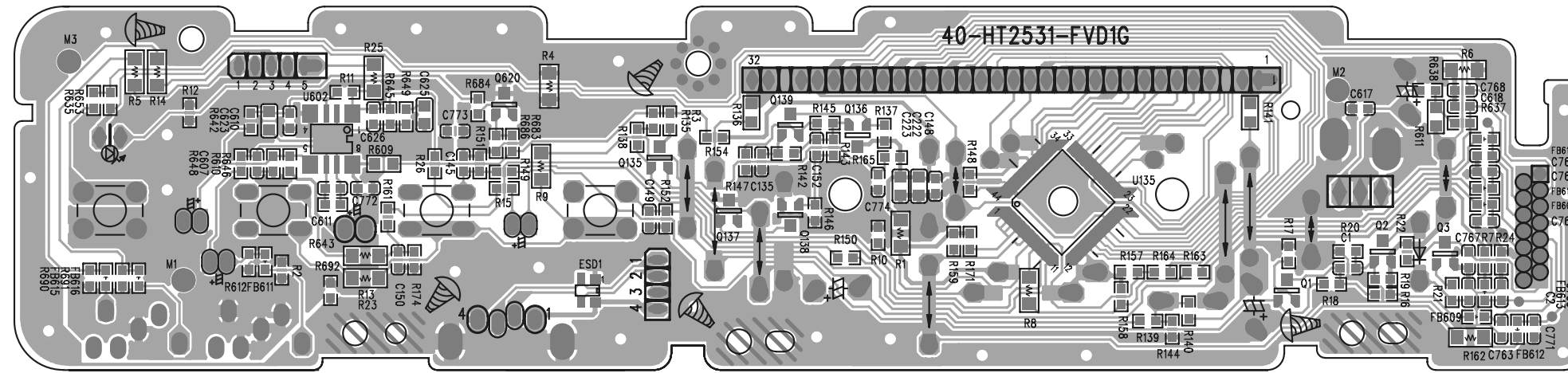

Power Supply Print-layout (Bottom Side):

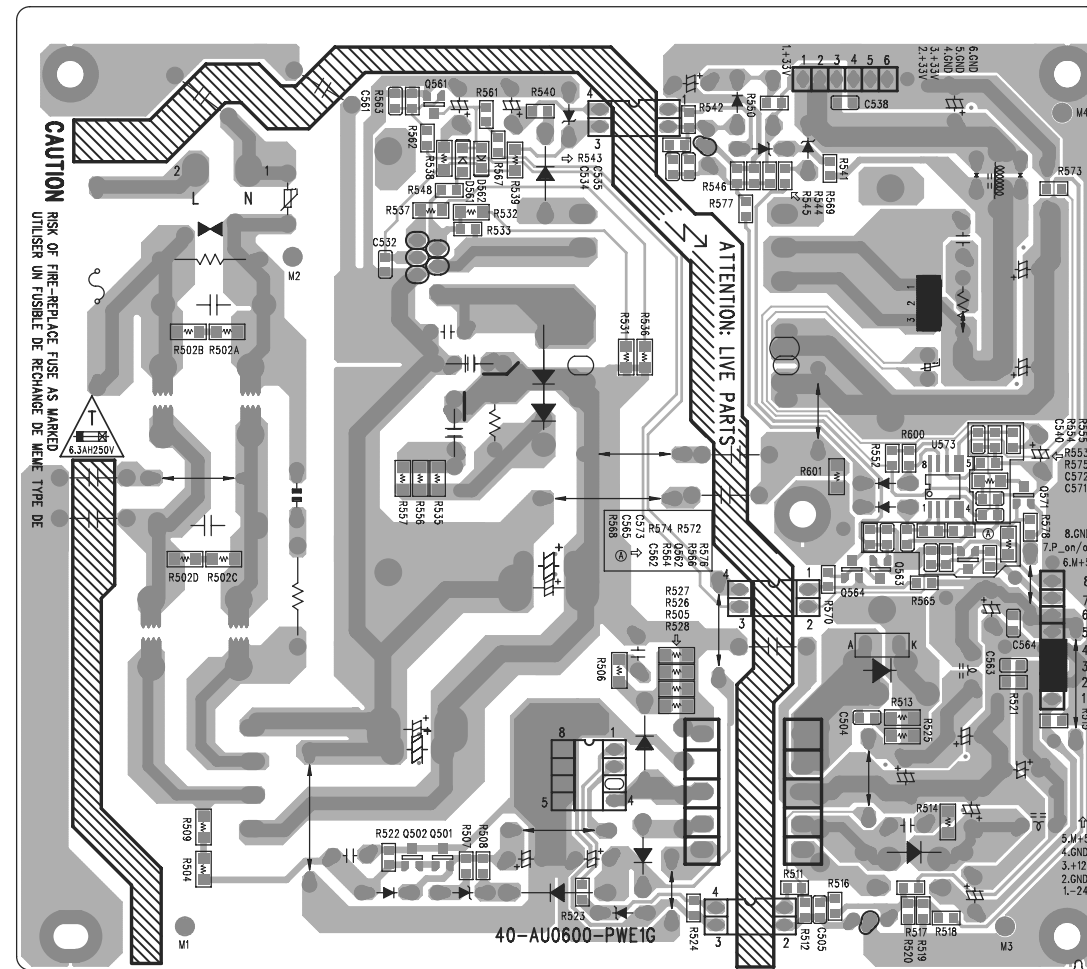

Amplifier Board Print-layout (Top Side):

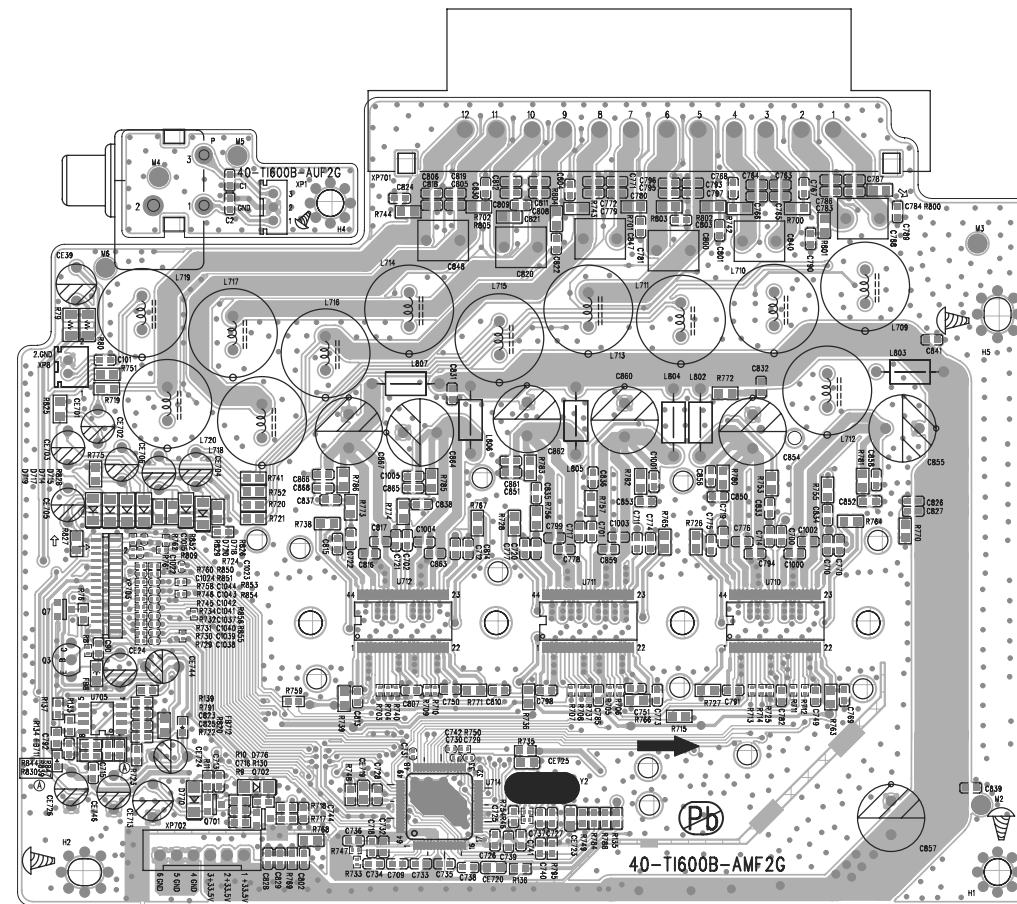

Amplifier Board Print-layout (Bottom Side):

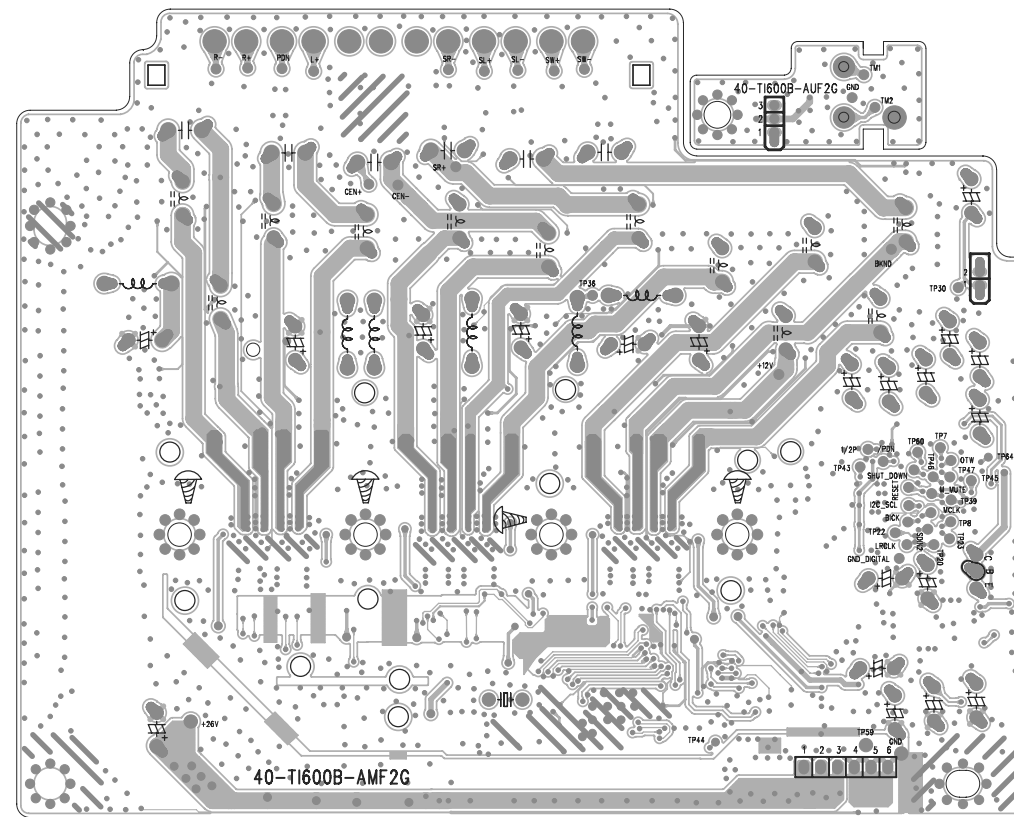

Main Board Print-layout for 9HTS3592/93M2(Top Side):

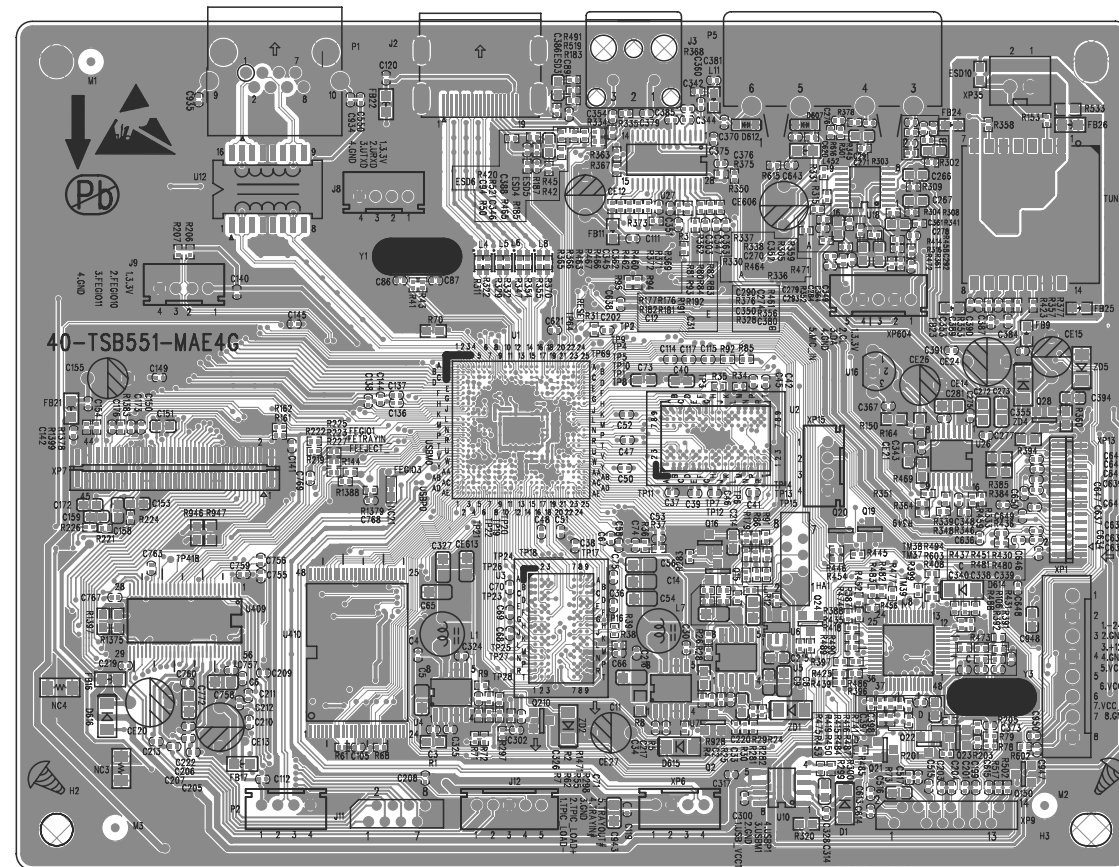

Main Board Print-layout for HTS3592/93M2(Bottom Side):

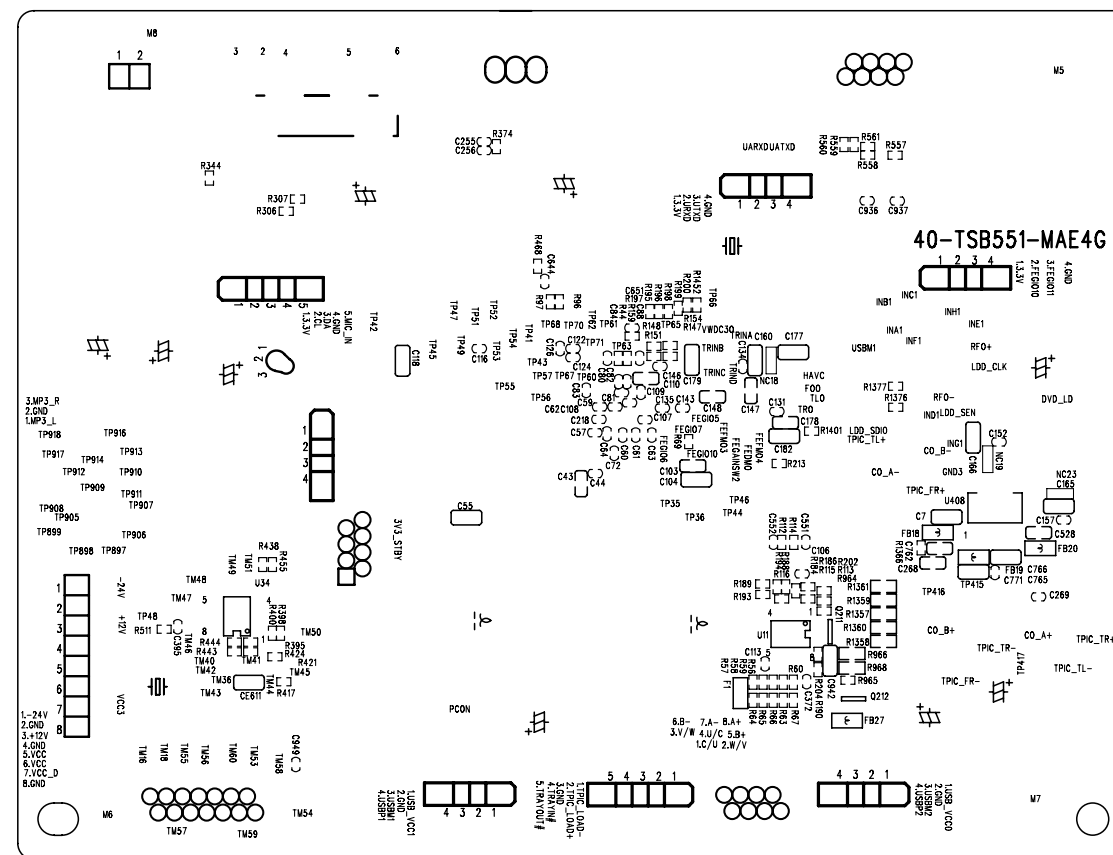

Exploded View For HTS3592M2/93:

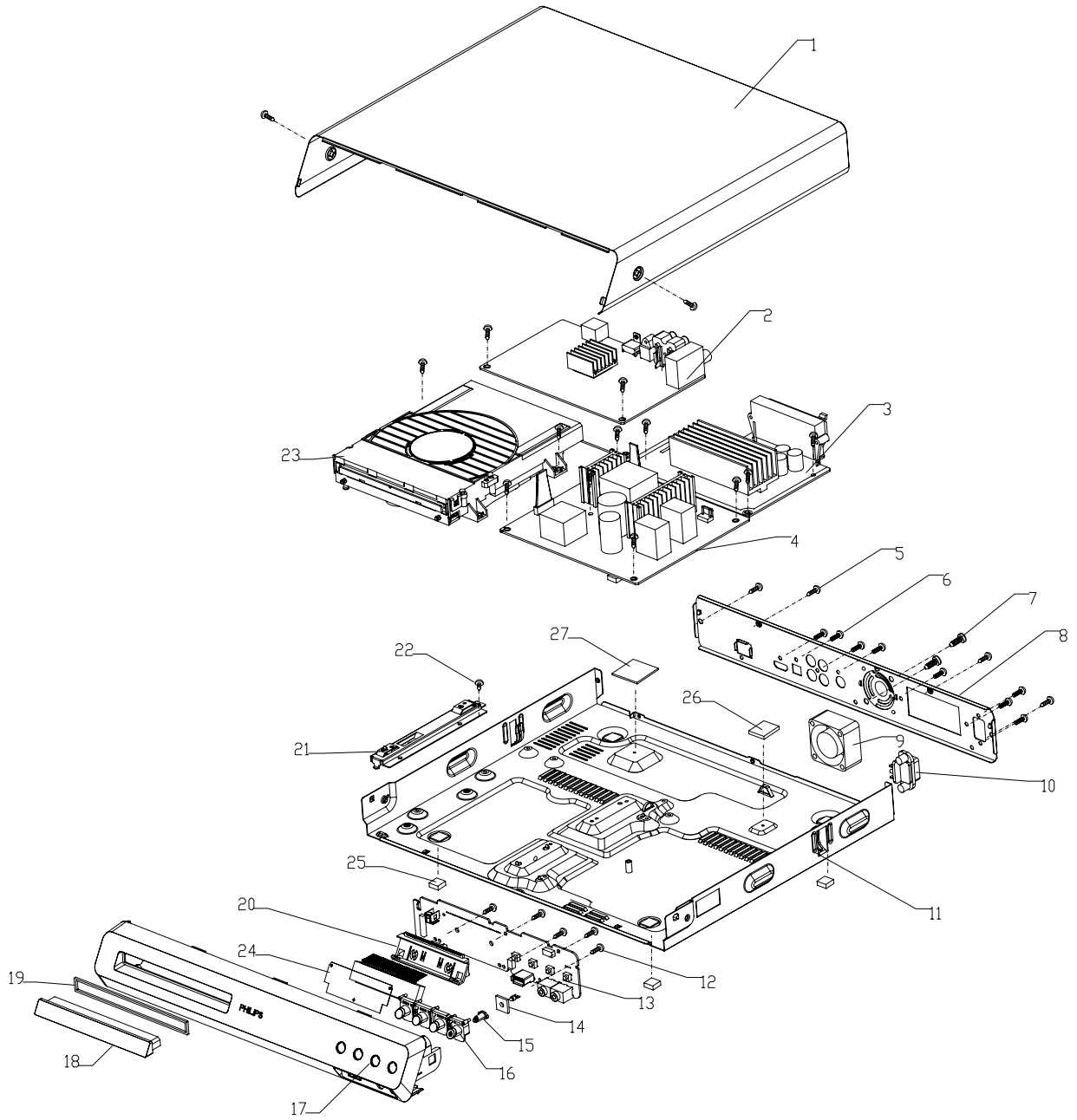

REVISION LIST

Version 1.0

* Initial release for HTS3592/93

Version 1.1

* Initial release for HTS3592M2/93